

1.0 INTRODUCTION TO STRUCTURAL ENGINEERING

1.1 GENERAL INTRODUCTION

Structural design is a systematic and iterative process that involves:

- 1) Identification of intended *use* and *occupancy* of a structure – by owner
- 2) Development of architectural plans and layout – by architect
- 3) Identification of structural framework – by engineer
- 4) Estimation of structural loads depending on use and occupancy
- 5) Analysis of the structure to determine member and connection design forces
- 6) Design of structural members and connections
- 7) Verification of design
- 8) Fabrication & Erection – by steel fabricator and contractor
- 9) Inspection and Approval – by state building official

Ideally, the owner and the architect, the architect and the engineer, and the engineer and the fabricator/contractor will collaborate and interact on a regular basis to conceive, develop, design, and build the structure in an efficient manner. The primary responsibilities of all these players are as follows:

- Owner - primary responsibility is deciding the use and occupancy, and approving the architectural plans of the building.
- Architect - primary responsibility is ensuring that the architectural plan of the building interior is appropriate for the intended use and the overall building is aesthetically pleasing.
- Engineer – primary responsibility is ensuring the safety and serviceability of the structure, i.e., designing the building to carry the loads safely and _____.
- Fabricator – primary responsibility is ensuring that the designed members and connections are fabricated economically in the shop or field as required.

- Contractor/Erector - primary responsibility is ensuring that the members and connections are economically assembled in the field to build the structure.
- State Building Official – primary responsibility is ensuring that the built structure satisfies the appropriate building codes accepted by the Govt.

1.2 STRUCTURAL DESIGN

- Conceptually, from an engineering standpoint, the parameters that can be varied (somewhat) are: (1) the material of construction, and (2) the structural framing plan.
- The choices for material include: (a) *steel*, (b) reinforced concrete, and (c) steel-concrete composite construction.
- The choices for structural framing plan include moment resisting frames, braced frames, dual frames, shear wall frames, and so on. The engineer can also *innovate* a new structural framing plan for a particular structure if required.
- All viable material + framing plan alternatives must be considered and designed to compare the individual material + fabrication / erection costs to identify the most efficient and economical design for the structure.
- For each material + framing plan alternative considered, designing the structure consists of designing the individual structural components, i.e., the members and the connections, of the framing plan.
- This course *CE405* focuses on the design of individual structural *components*. The material of construction will limited be steel, and the structural framing plans will be limited to braced frames and moment resisting frames.

1.3 STRUCTURAL FRAMEWORK

- Figure 1 shows the structural plan and layout of a *four*-story office building to be located in Lansing. Figure 2 and 3 show the structural elevations of frames A-A and B-B, respectively, which are identified in Figure 1.

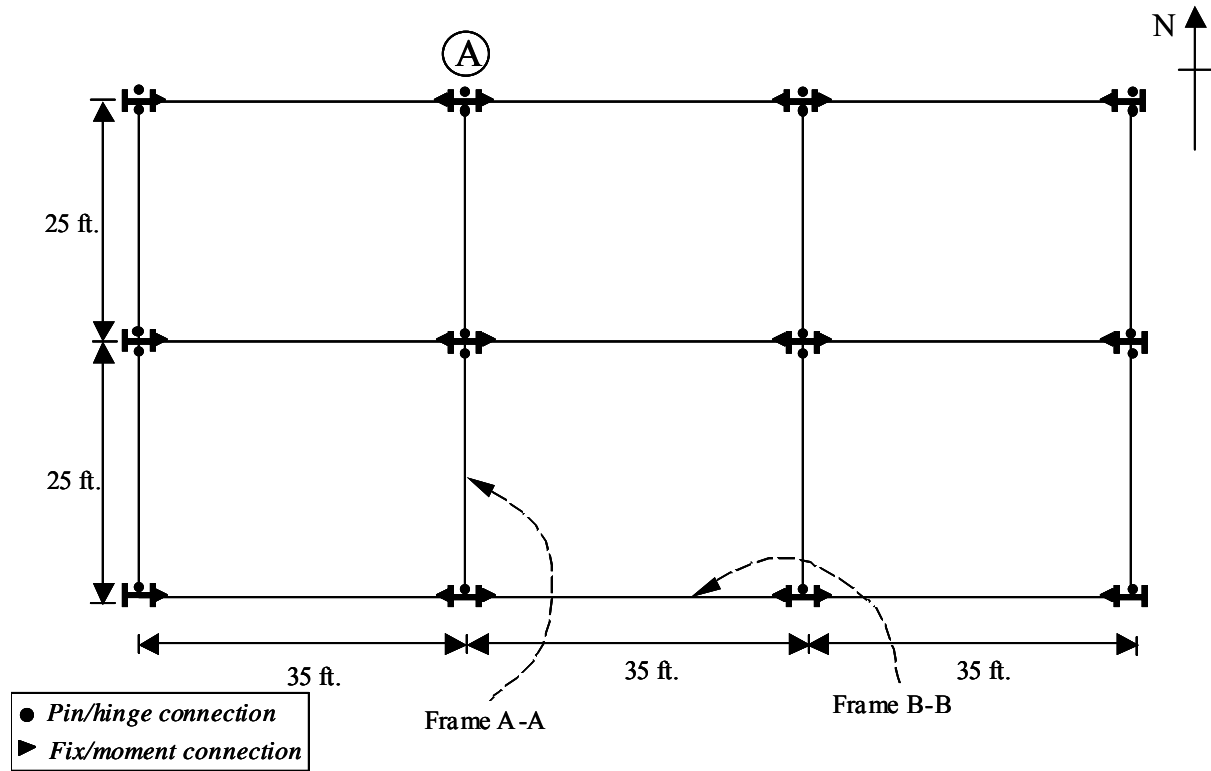

Figure 1. Structural floor plan and layout

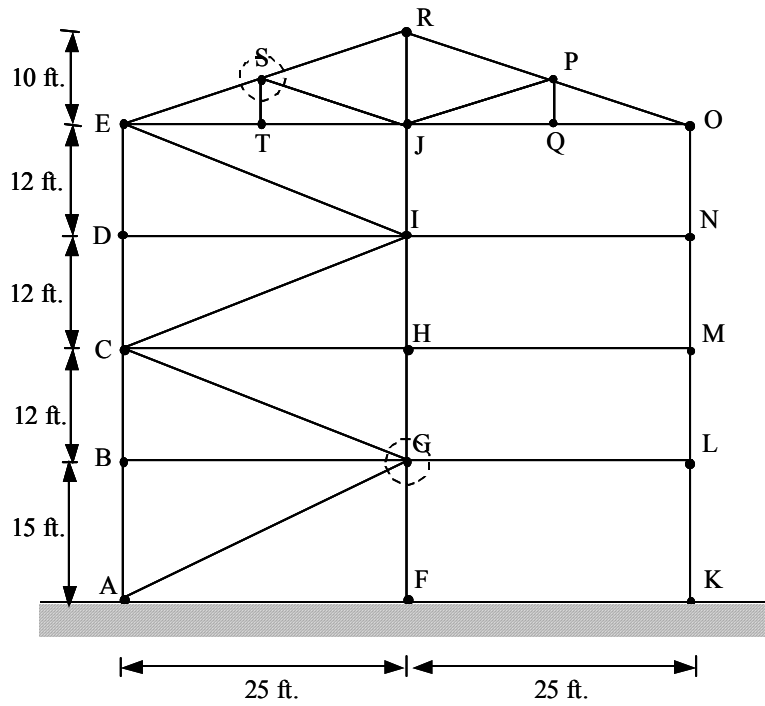

Figure 2. Structural elevation of frame A-A

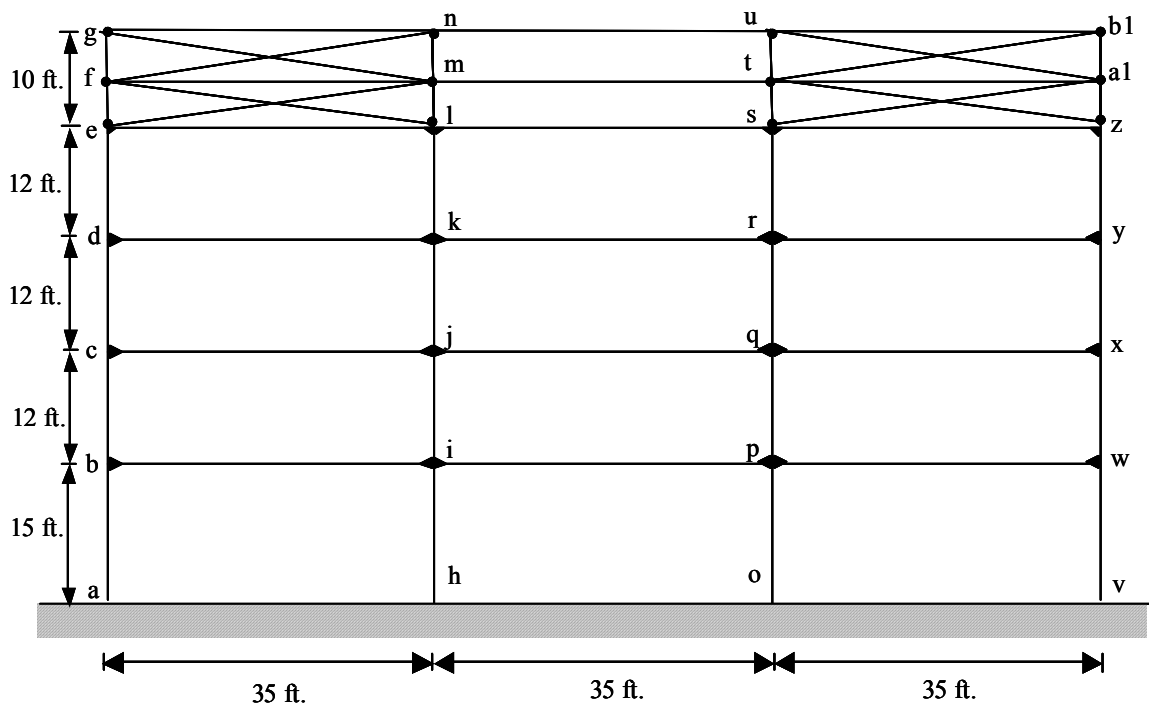
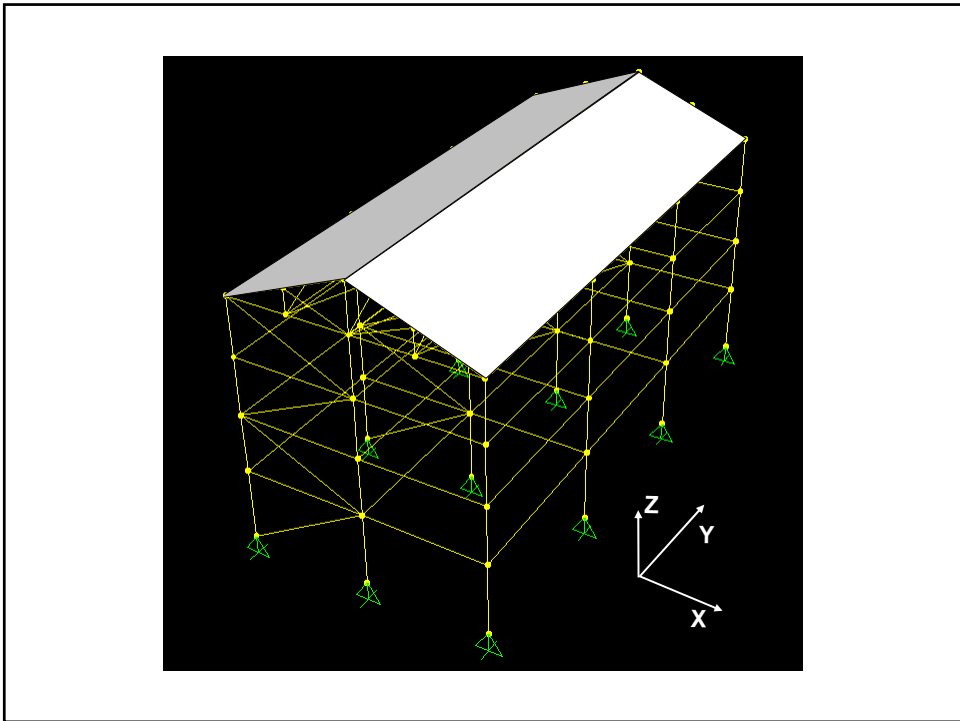
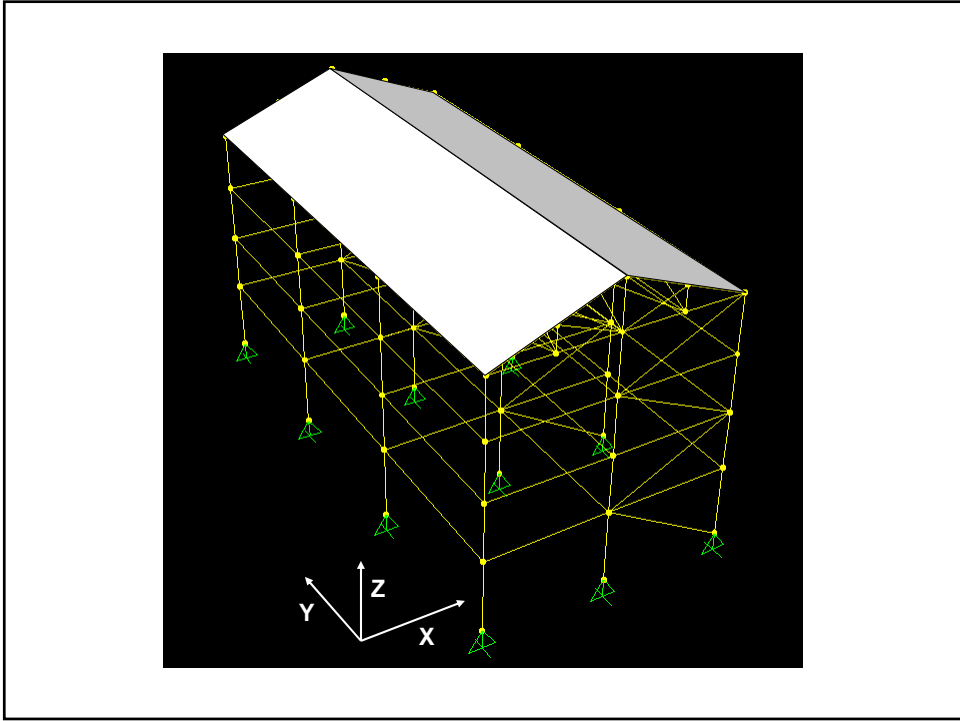
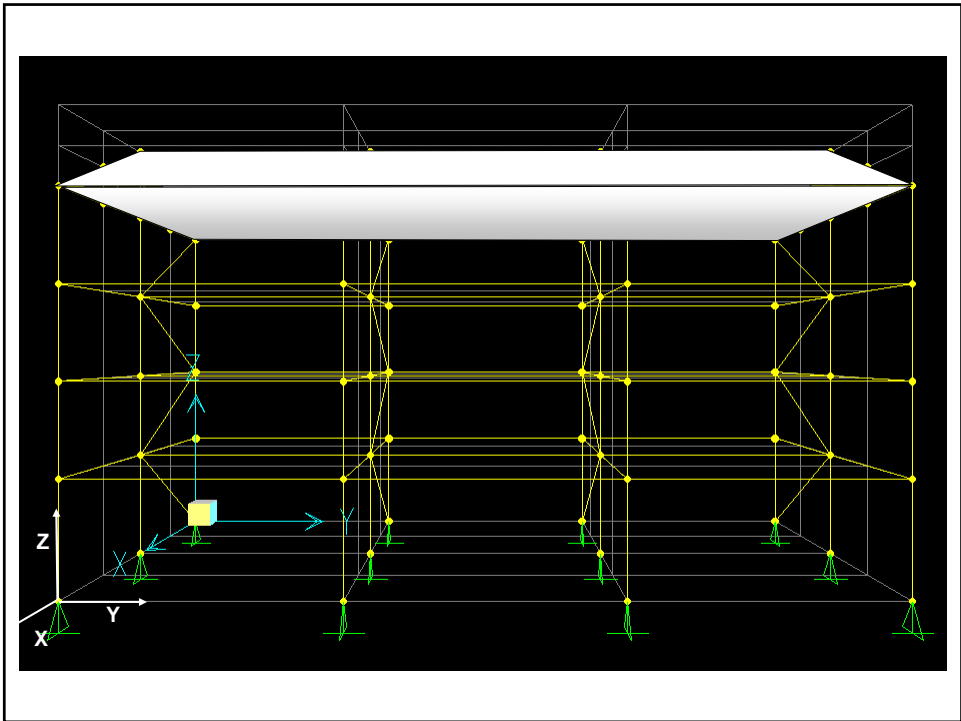
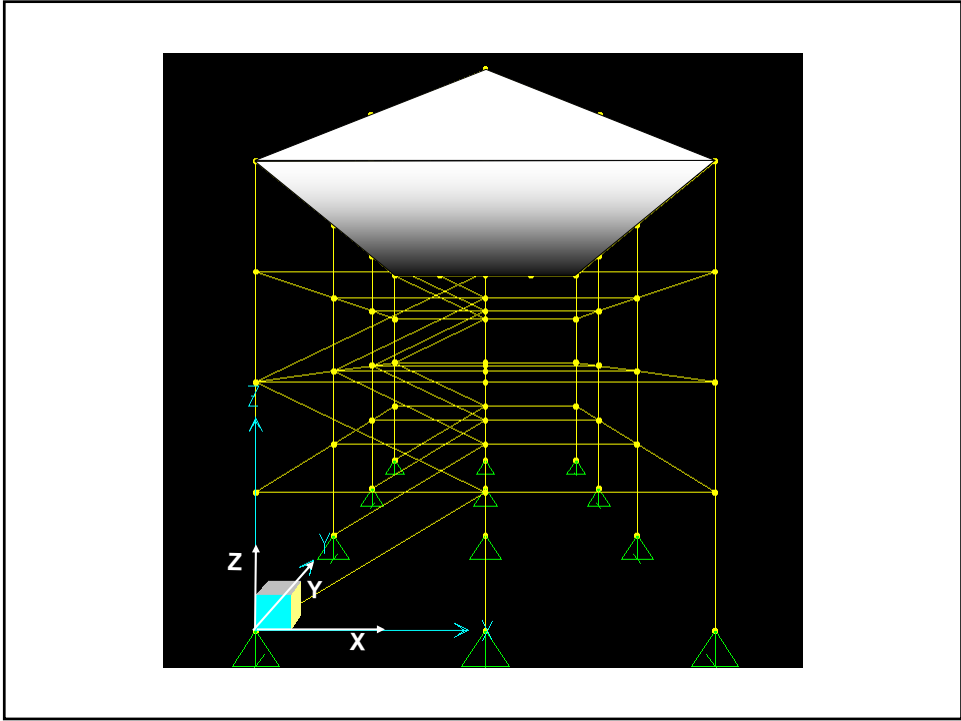
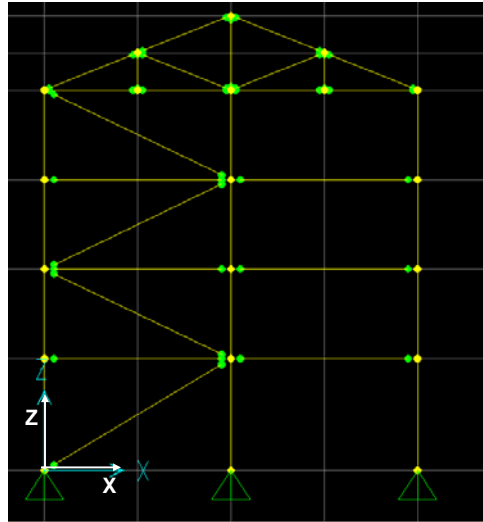

Figure 3. Structural elevation of frame B-B

- As shown in Figure 1, the building has two 25-ft. bays in the *north-south* direction and three 35 ft. bays in the *east-west* direction.
- There are *four* structural frames in the north-south direction. These frames have structural elevations similar to frame A-A shown in Figure 2.
- There are *three* structural frames in the east-west directions. These frames have structural elevations similar to frame B-B shown in Figure 3.
- The building has a *roof truss*, which is shown in Figures 2 and 3.
- Frame A-A is a braced frame, where all members are connected using *pin/hinge connections*. Diagonal bracing members are needed for stability.
- Frame B-B is a moment frame, where all members are connected using *fix/moment connections*. There is no need for diagonal bracing members.
- The north-south and east-west frames resist the *vertical gravity* loads together.
- The three moment frames in the east-west direction resist the *horizontal lateral loads* in the east-west direction.







ELEVATION OF BRACED FRAME

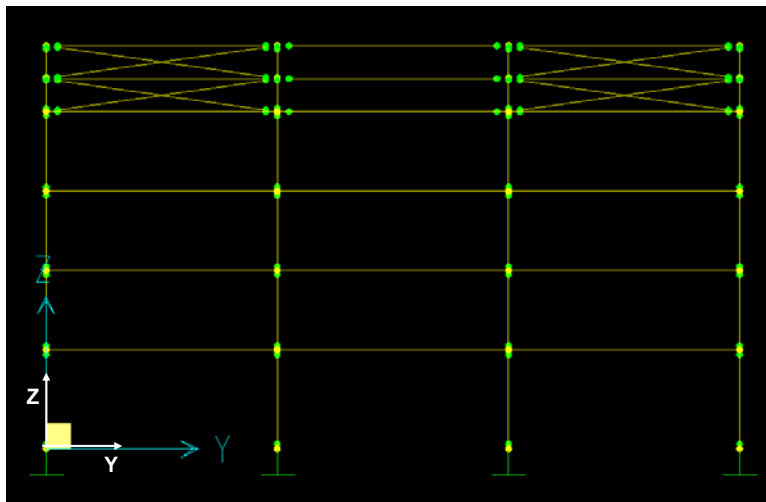

ELEVATION OF MOMENT FRAME

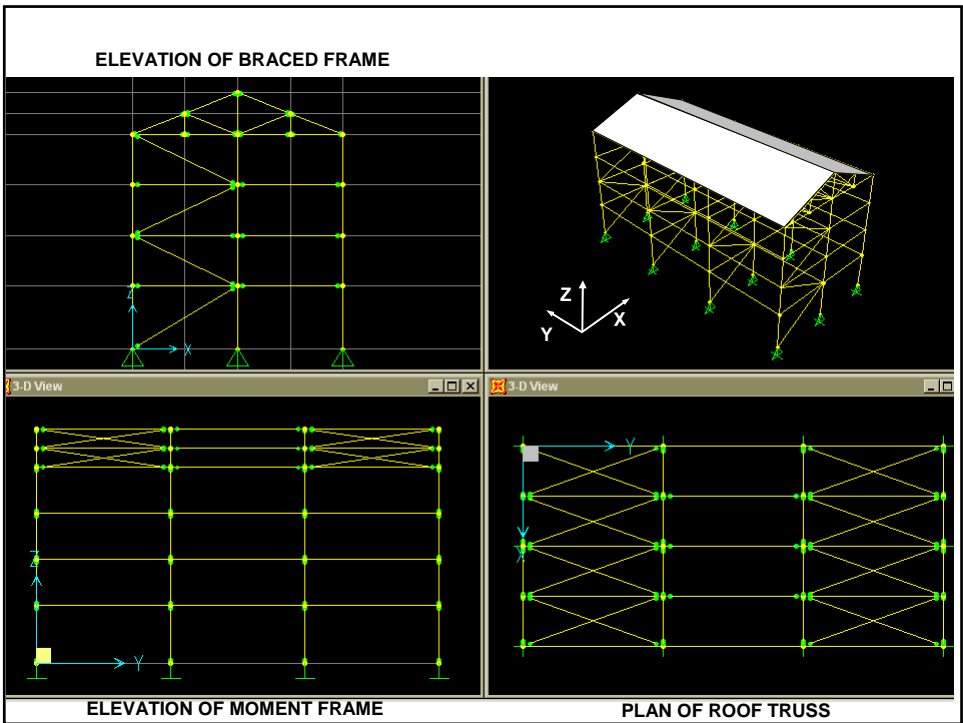
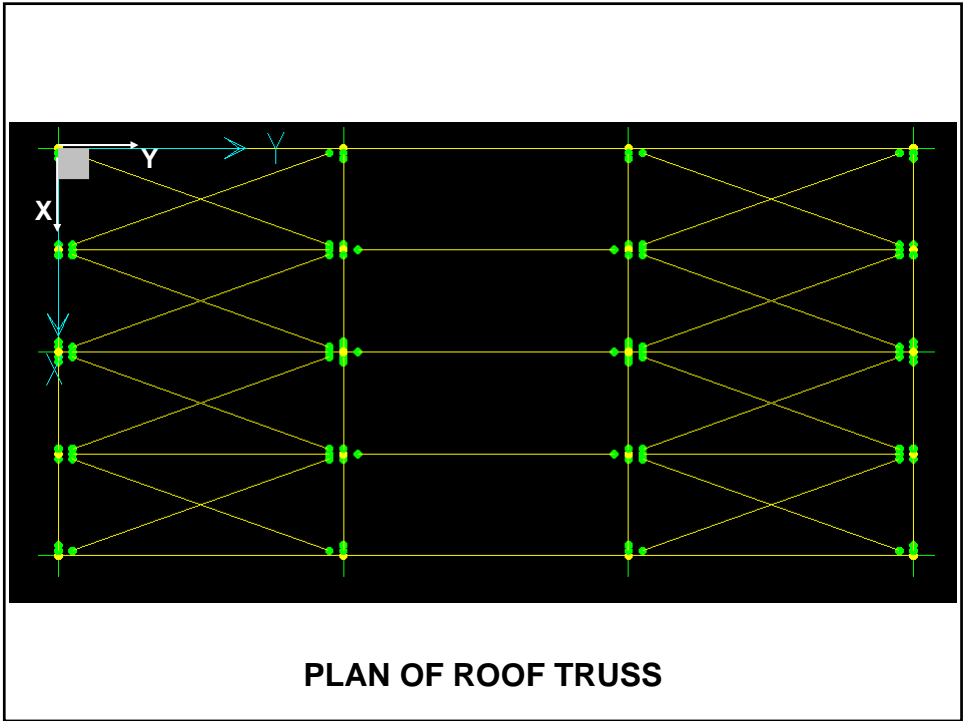

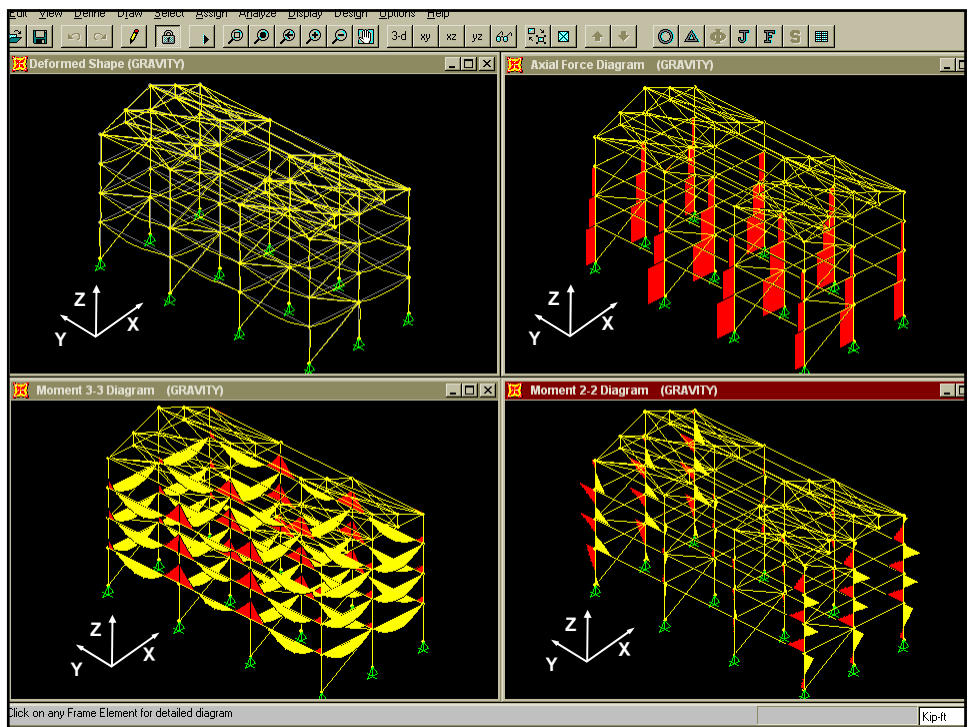
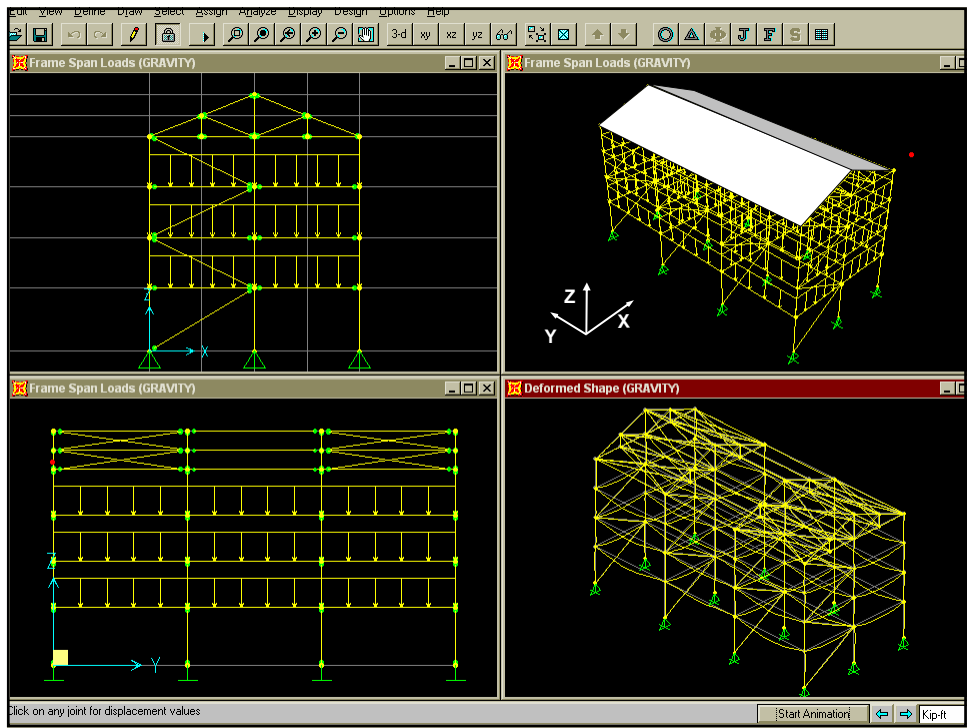

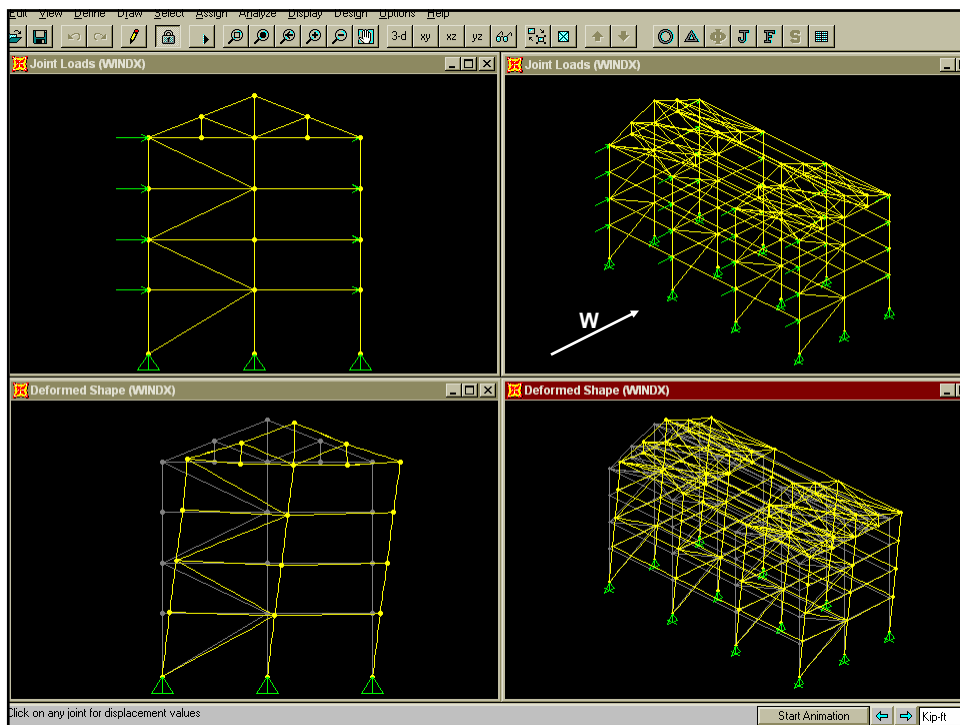
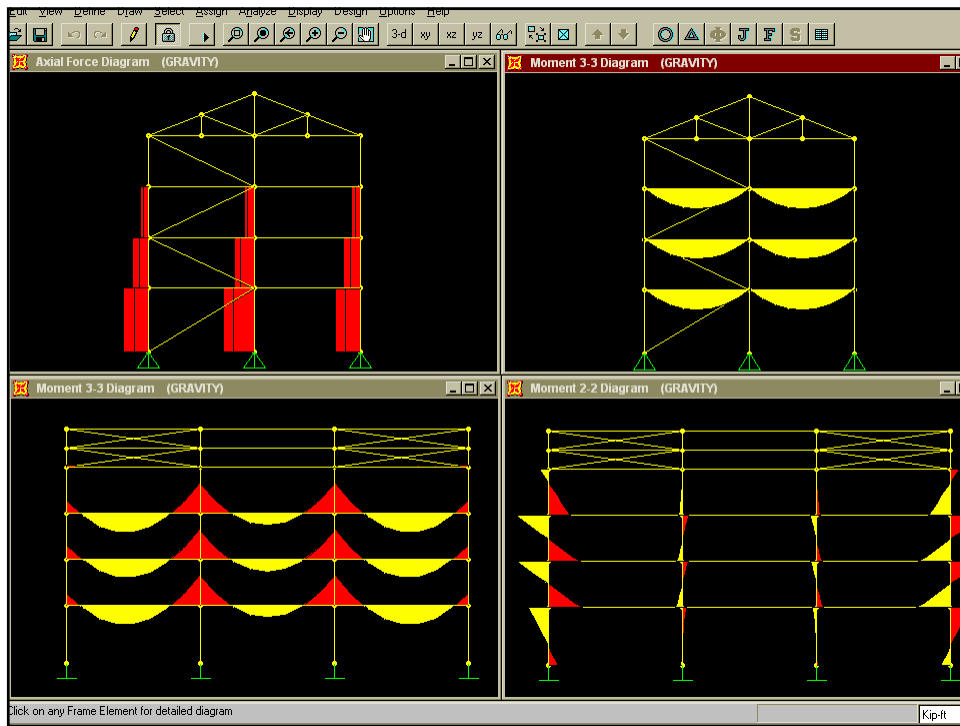

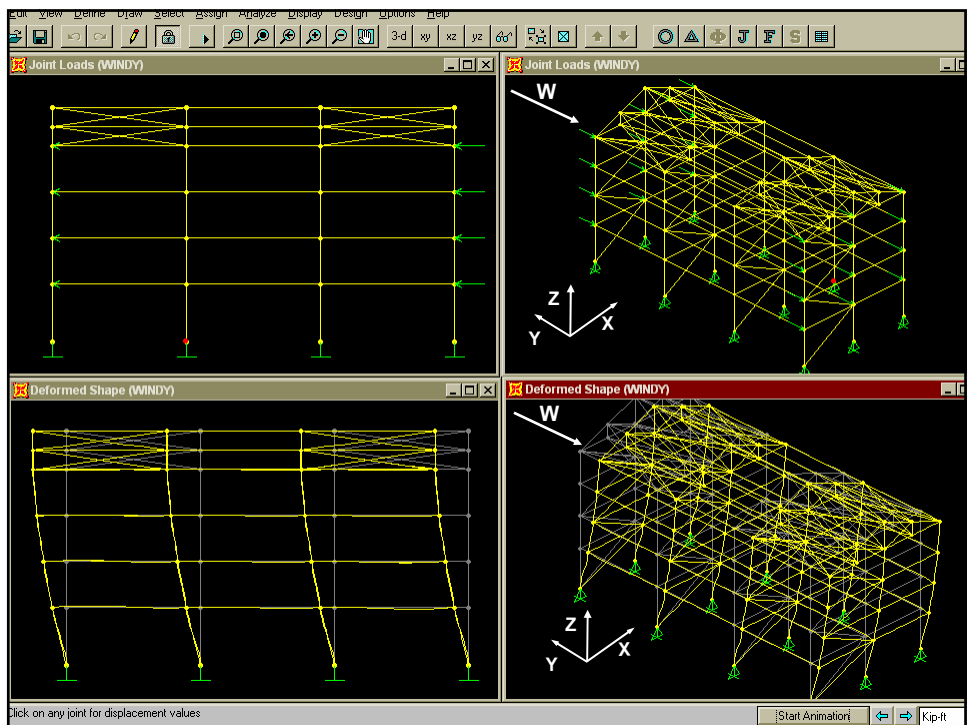
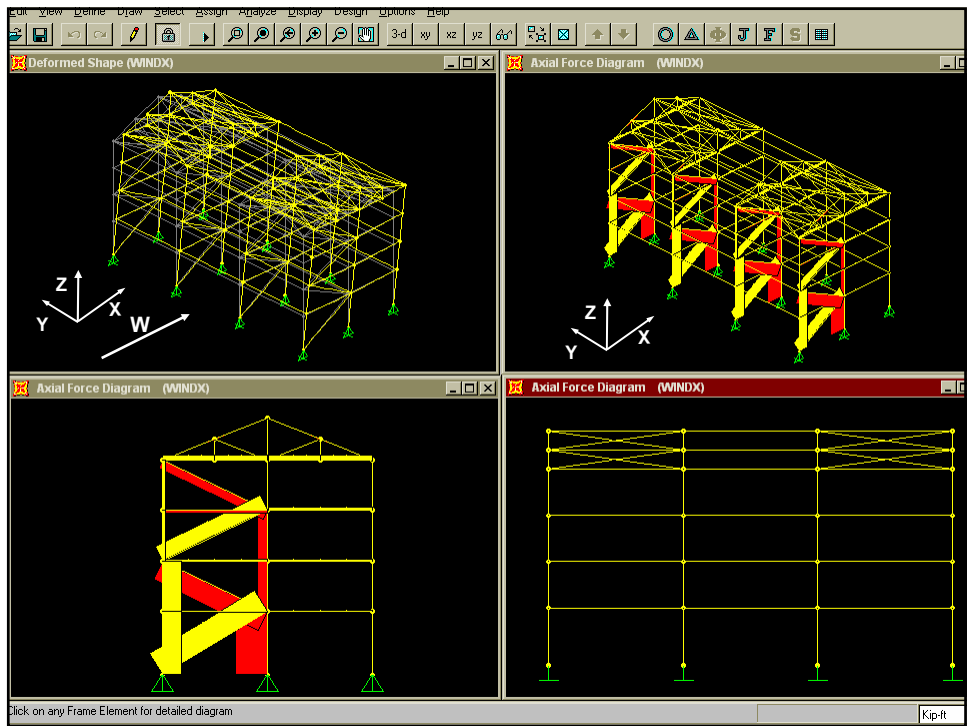

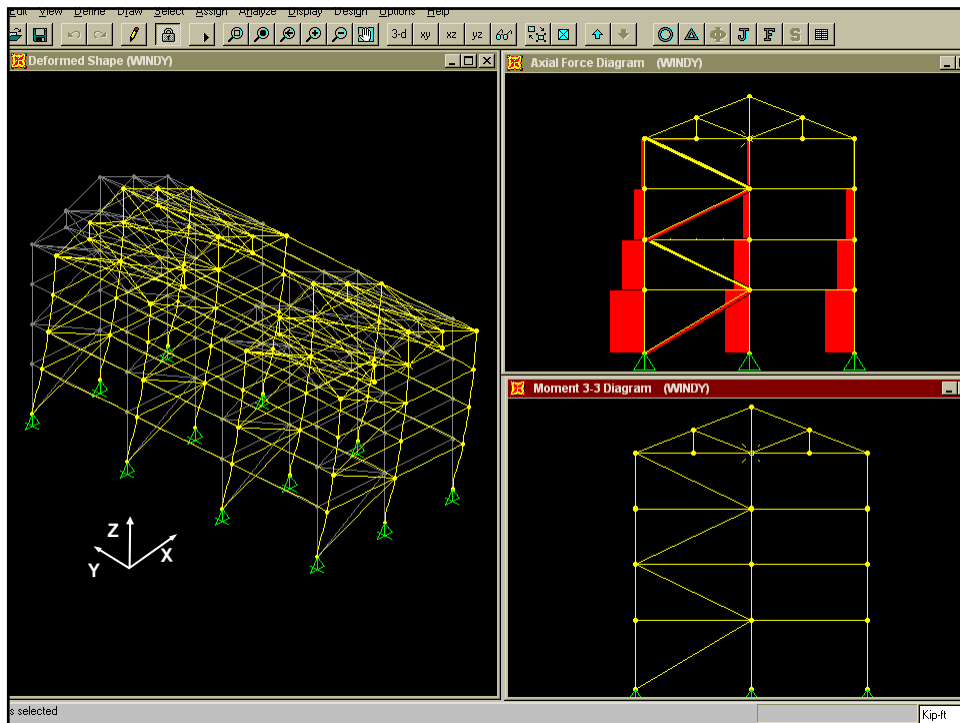
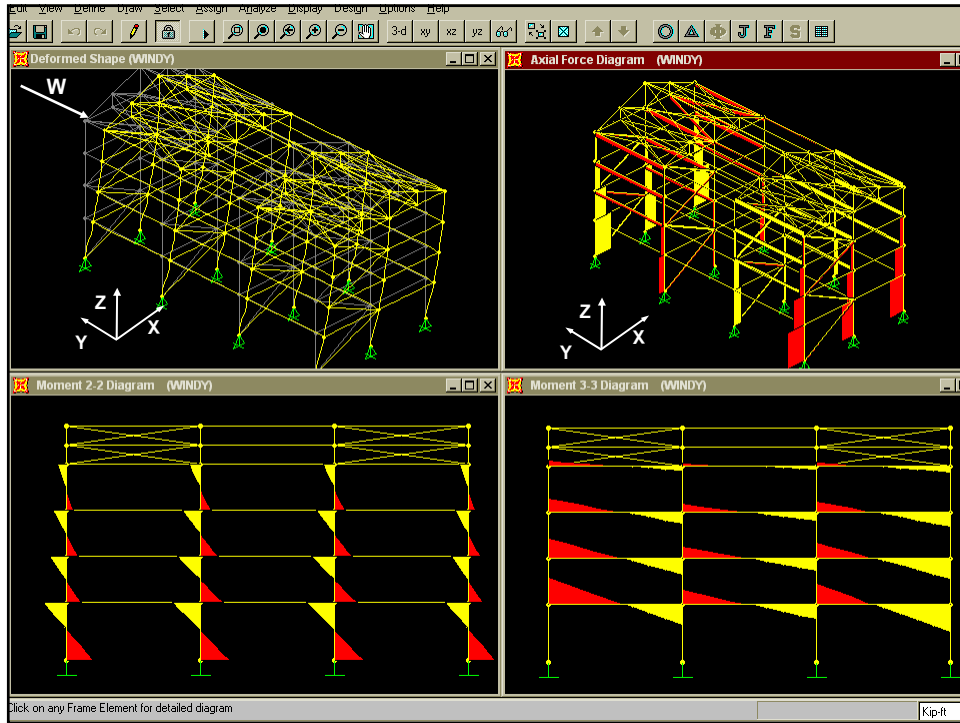

- The four braced frames in the north-south direction resist the *horizontal lateral loads* in the north-south direction.

1.4 STRUCTURAL MEMBERS

Structural members are categorized based up on the internal forces in them. For example:

- Tension member –subjected to tensile axial force only
- Column or compression member –subjected to compressive axial force only
- Tension/Compression member –subjected to tensile/compressive axial forces
- Beam member –subjected to flexural loads, i.e., shear force and bending moment only. The axial force in a beam member is negligible.
- Beam-column member – member subjected to combined axial force and flexural loads (shear force, and bending moments)

In basic structural analysis (*CE305*) students have come across two types of structures, namely, *trusses and frames*. For example, Figure 2 shows a roof truss supported by a braced frame.

- All the members of a truss are connected using pin/hinge connections. All external forces are applied at the pins/hinges. As a result, all truss members are subjected to axial forces (tension or compression) only.
- In braced and moment frames, the horizontal members (beams) are subjected to flexural loads only.
- In braced frames, the vertical members (columns) are subjected to compressive axial forces only.
- In braced frames, the diagonal members (braces) are subjected to tension/compression axial forces only.
- In moment frames, the vertical members (beam-columns) are subjected to combined axial and flexural loads.

For practice, let us categorize the member shown in Figures 2 and 3.

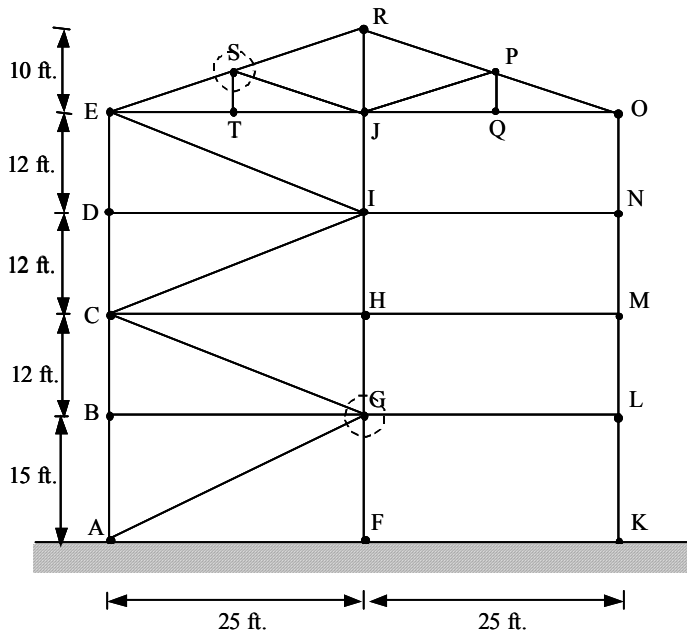

Figure 2. Structural elevation of frame A-A

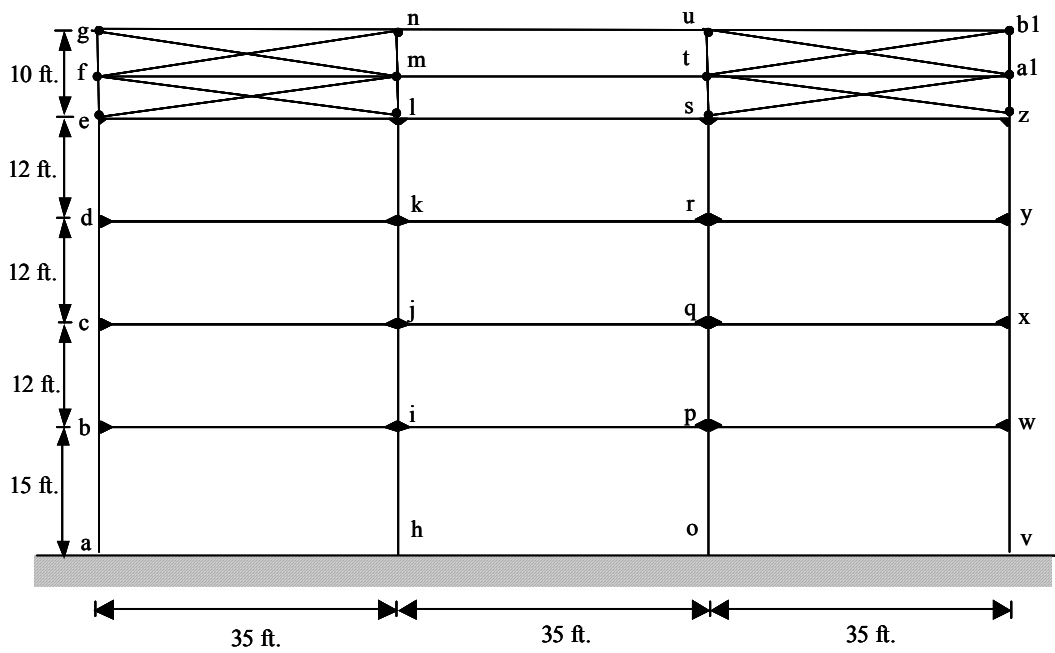

Figure 3. Structural elevation of frame B-B

1.5 STRUCTURAL CONNECTIONS

Members of a structural frame are connected together using connections. Prominent connection types include: (1) truss / bracing member connections; (2) simple shear connections; (3) fully-restrained moment connections; and (4) partially-restrained flexible moment connections.

- Truss / bracing member connections are used to connect two or more truss members together. Only the *axial forces* in the members have to be transferred through the connection for continuity.
- Simple shear connections are the *pin connections* used to connect beam to column members. Only the *shear forces* are transferred through the connection for continuity. The *bending moments* are not transferred through the connection.
- Moment connections are *fix connections* used to connect beam to column members. Both the shear forces and bending moments are transferred through the connections with very small deformations (*full restraint*).
- Partially restrained connections are *flexible connections* used to connect beam to column members. The shear forces are transferred fully through the connection. However, the bending moment is only transferred partially.

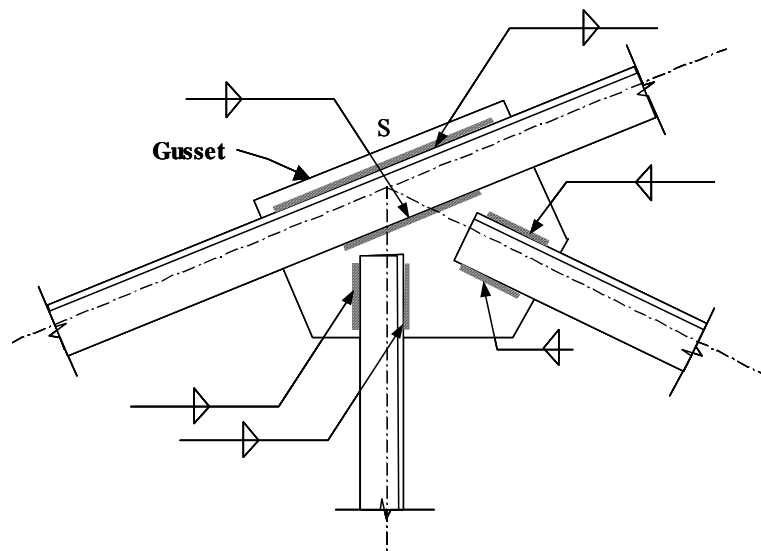

Figure 4. Truss connection at S in Frame A-A.

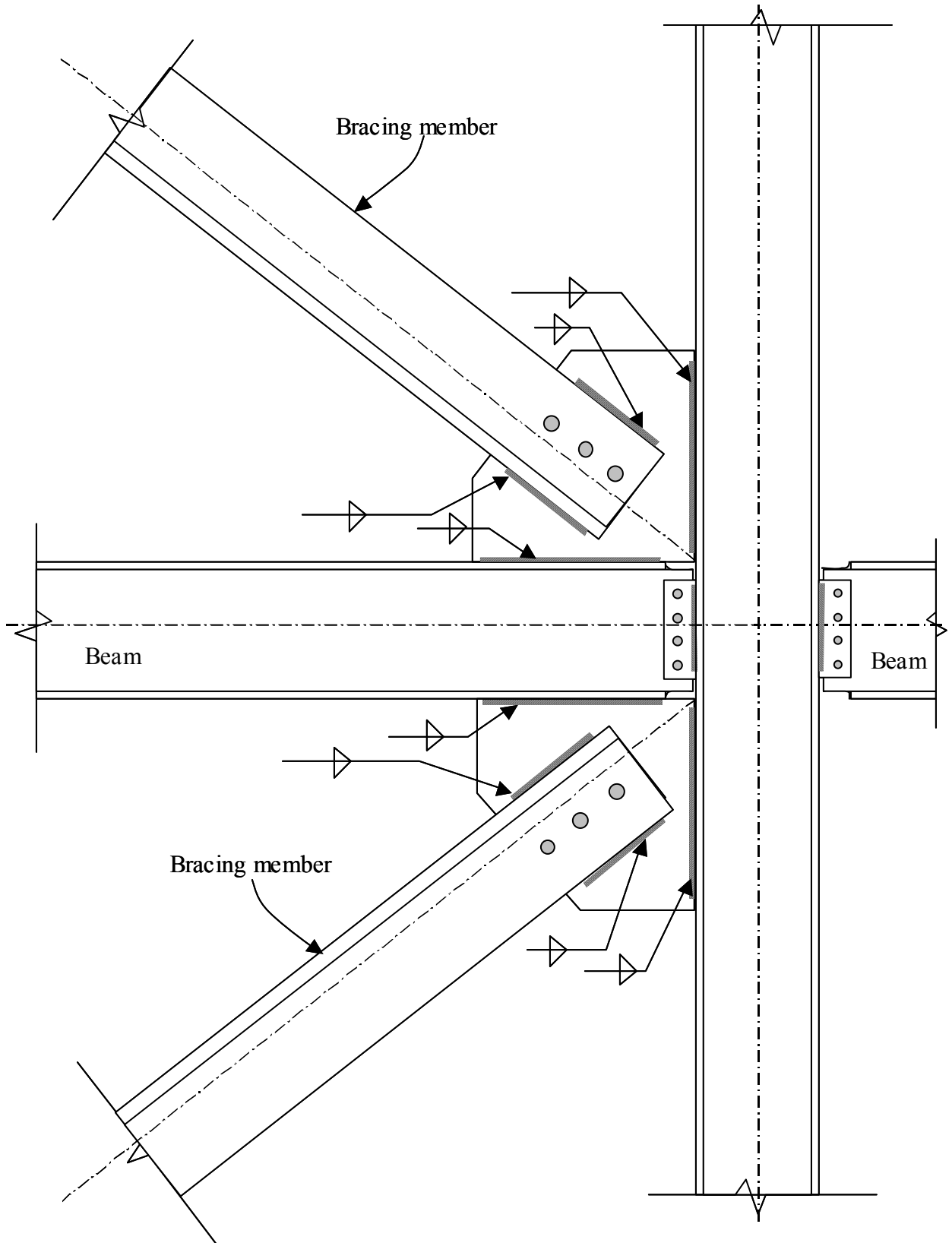

Figure 5. Bracing connection and Simple Shear Connection at **G** in Frame A-A.

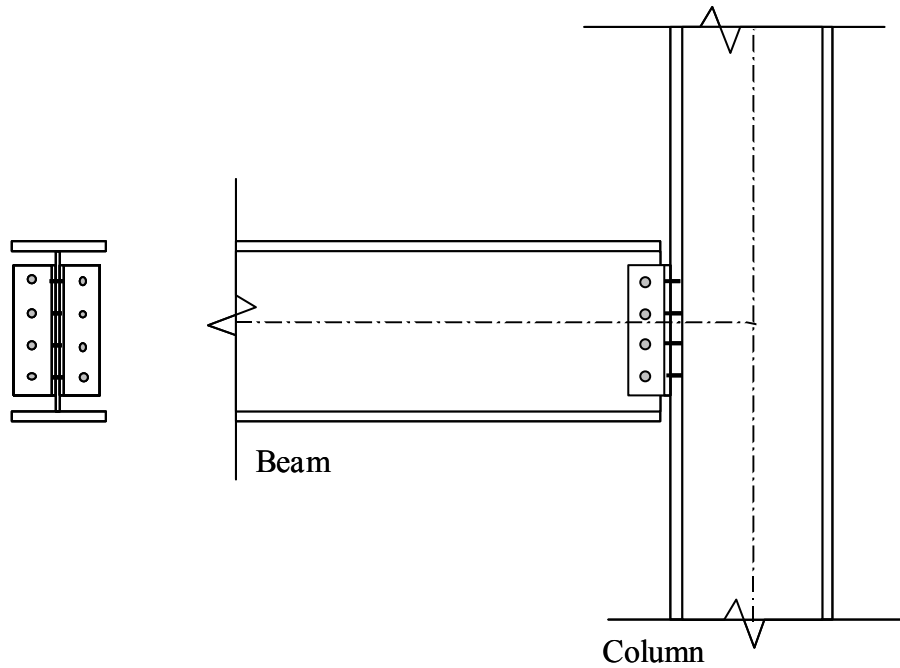

Figure 6. All-bolted double angle shear connection.

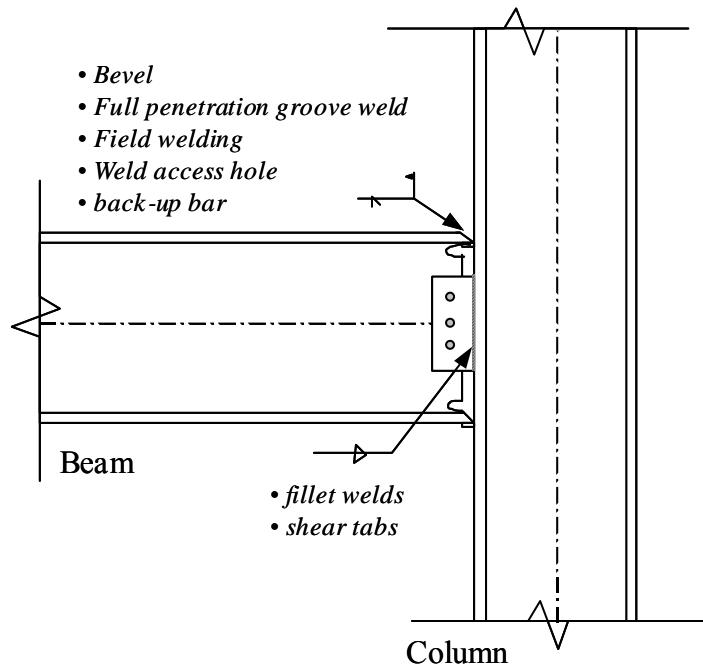

Figure 7. Directly welded flange fully restrained moment connection.

- Figure 4 shows an example truss connection. Figure 5 shows an example bracing connection. Figure 6 shows an example shear connection. Figure 7 shows an example moment connection.
- Connections are developed using bolts or welds.
- Bolts are used to connect two or more plate elements that are in the same plane. Bolt-holes are drilled in the plate elements. The *threaded* bolt shank passes through the holes, and the connection is secured using *nuts*.
- Bolts are usually made of *higher strength steel*.
- Welds can be used to connect plate elements that are in the same or different planes. A high voltage *electric arc* is developed between the two plate elements. The electric arc causes localized melting of the base metal (plate element) and the weld electrode. After cooling, all the molten metal (base and weld) solidifies into one *continuum*. Thus, developing a welded connection.
- In Figure 4, all the truss members are connected together by welding to a common *gusset* plate. The axial forces in the members are transferred through the *gusset* plates. This same connection can also be developed using bolts. *How?*
- In Figure 5, the bracing members are connected to *gusset* plates, which are also connected to the beam and column. The bracing member can be connected to the *gusset* plate using bolts or welds. However, the *gusset* plate has to be welded to the beam / column.
- In Figure 6, two angles are bolted to the web of the beam. The perpendicular legs of the angles are bolted to the flange of the column. Thus, an all-bolted double-angle shear connection is achieved. This all-bolted connection will be easier to assemble in the field as compared to welding. *How is this a shear connection?*
- In Figure 7, the beam flanges are *beveled* and welded directly to the flange of column using full penetration groove welds. This welding will have to be done in the *field* during erection and it will require the use of back-up bars. Weld-access holes and skilled welders are required to achieve a weld of acceptable quality.
- In Figure 7, the beam web is bolted to a shear tab (plate), which is fillet welded to the column in the shop. This shear tab connection transfers the shear from the beam to the column. *How is Figure 7 a moment connection?*

1.6 Structural Loads

The building structure must be designed to carry or resist the loads that are applied to it over its design-life. The building structure will be subjected to loads that have been categorized as follows:

- Dead Loads (D): are permanent loads acting on the structure. These include the self-weight of structural and non-structural components. They are usually *gravity* loads.
- Live Loads (L): are non-permanent loads acting on the structure due to its use and occupancy. The magnitude and location of live loads changes frequently over the design life. Hence, they cannot be estimated with the same accuracy as dead loads.
- Wind Loads (W): are in the form of *pressure* or *suction* on the exterior surfaces of the building. They cause horizontal lateral loads (forces) on the structure, which can be critical for tall buildings. Wind loads also cause *uplift* of light roof systems.
- Snow Loads (S): are vertical gravity loads due to snow, which are subjected to variability due to seasons and drift.
- Roof Live Load (L_r): are live loads on the roof caused during the design life by planters, people, or by workers, equipment, and materials during maintenance.
- Values of structural loads are given in the publication ASCE 7-98: *Minimum Design Loads for Buildings and Other Structures*. The first phase of structural design consists of estimating the loads acting on the structure. This is done using the load values and combinations presented in ASCE 7-98 as explained in the following sub-sections.

1.6.1 Step I. Categorization of Buildings

- Categories I, II, III, and IV. See Table 1.1 below and in ASCE 7-98.

TABLE 1-1. Classification of Buildings and Other Structures for Flood, Wind, Snow, and Earthquake Loads

Nature of Occupancy	Category
Buildings and other structures that represent a low hazard to human life in the event of failure including, but not limited to: <ul style="list-style-type: none"> • Agricultural facilities • Certain temporary facilities • Minor storage facilities 	I
All buildings and other structures except those listed in Categories I, III and IV	II
Buildings and other structures that represent a substantial hazard to human life in the event of failure including, but not limited to: <ul style="list-style-type: none"> • Buildings and other structures where more than 300 people congregate in one area • Buildings and other structures with day-care facilities with capacity greater than 150 • Buildings and other structures with elementary or secondary school facilities with capacity greater than 150 • Buildings and other structures with a capacity greater than 500 for colleges or adult education facilities • Health care facilities with a capacity of 50 or more resident patients but not having surgery or emergency treatment facilities • Jails and detention facilities • Power generating stations and other public utility facilities not included in Category IV 	III
Buildings and other structures containing sufficient quantities of toxic, explosive or other hazardous substances to be dangerous to the public if released including, but not limited to: <ul style="list-style-type: none"> • Petrochemical facilities • Fuel storage facilities • Manufacturing or storage facilities for hazardous chemicals • Manufacturing or storage facilities for explosives 	
Buildings and other structures that are equipped with secondary containment of toxic, explosive or other hazardous substances (including, but not limited to double wall tank, dike of sufficient size to contain a spill, or other means to contain a spill or a blast within the property boundary of the facility and prevent release of harmful quantities of contaminants to the air, soil, ground water, or surface water) or atmosphere (where appropriate) shall be eligible for classification as a Category II structure.	IV
In hurricane prone regions, buildings and other structures that contain toxic, explosive, or other hazardous substances and do not qualify as Category IV structures shall be eligible for classification as Category II structures for wind loads if these structures are operated in accordance with mandatory procedures that are acceptable to the authority having jurisdiction and which effectively diminish the effects of wind on critical structural elements or which alternatively protect against harmful releases during and after hurricanes.	
Buildings and other structures designated as essential facilities including, but not limited to: <ul style="list-style-type: none"> • Hospitals and other health care facilities having surgery or emergency treatment facilities • Fire, rescue and police stations and emergency vehicle garages • Designated earthquake, hurricane, or other emergency shelters • Communications centers and other facilities required for emergency response • Power generating stations and other public utility facilities required in an emergency • Ancillary structures (including, but not limited to communication towers, fuel storage tanks, cooling towers, electrical substation structures, fire water storage tanks or other structures housing or supporting water or other fire-suppression material or equipment) required for operation of Category IV structures during an emergency • Aviation control towers, air traffic control centers and emergency aircraft hangars • Water storage facilities and pump structures required to maintain water pressure for fire suppression • Buildings and other structures having critical national defense functions 	

1.6.2 Dead Loads (D)

Dead loads consist of the weight of all materials of construction incorporated into the building including but not limited to walls, floors, roofs, ceilings, stairways, built-in partitions, finishes, cladding and other similarly incorporated architectural and structural items, and fixed service equipment such as plumbing stacks and risers, electrical feeders, and heating, ventilating, and air conditioning systems.

In some cases, the structural dead load can be estimated satisfactorily from simple formulas based in the weights and sizes of similar structures. For example, the average weight of steel framed buildings is 60-75 lb/ft², and the average weight for reinforced concrete buildings is 110 - 130 lb/ft².

From an engineering standpoint, once the materials and sizes of the various components of the structure are determined, their weights can be found from tables that list their densities. See Tables 1.2 and 1.3, which are taken from Hibbeler, R.C. (1999), *Structural Analysis*, 4th Edition.

Table 1–2 Minimum Densities for Design Loads from Materials*

	lb/ft ³	kN/m ³
Aluminum	170	26.7
Concrete, plain cinder	108	17.0
Concrete, plain stone	144	22.6
Concrete, reinforced cinder	111	17.4
Concrete, reinforced stone	150	23.6
Clay, dry	63	9.9
Clay, damp	110	17.3
Sand and gravel, dry, loose	100	15.7
Sand and gravel, wet	120	18.9
Masonry, lightweight solid concrete	105	16.5
Masonry, normal weight	135	21.2
Plywood	36	5.7
Steel, cold-drawn	492	77.3
Wood, Douglas Fir	34	5.3
Wood, Southern Pine	37	5.8
Wood, spruce	29	4.5

Table 1–3 Minimum Design Dead Loads*

	psf	kN/m ²
<i>Walls</i>		
4-in. (102 mm) clay brick	39	1.87
8-in. (203 mm) clay brick	79	3.78
12-in. (305 mm) clay brick	115	5.51
<i>Frame Partitions and Walls</i>		
Exterior stud walls with brick veneer	48	2.30
Windows, glass, frame and sash	8	0.38
Wood studs 2 × 4, (51 × 102) unplastered	4	0.19
Wood studs 2 × 4, (51 × 102) plastered one side	12	0.57
Wood studs 2 × 4, (51 × 102) plastered two sides	20	0.96
<i>Floor Fill</i>		
Cinder concrete, per inch (mm)	9	0.017
Lightweight concrete, plain, per inch (mm)	8	0.015
Stone concrete, per inch (mm)	12	0.023
<i>Ceilings</i>		
Acoustical fiberboard	1	0.05
Plaster on tile or concrete	5	0.24
Suspended metal lath and gypsum plaster	10	0.48
Asphalt shingles	2	0.10
Fiberboard, $\frac{1}{2}$ -in. (13 mm)	0.75	0.04

*Reproduced with permission from American Society of Civil Engineers *Minimum Design Loads for Buildings and Other Structures*, ANSI/ASCE 7-95. Copies of this standard may be purchased from ASCE at 345 East 47th Street, New York, N.Y. 10017-2398.

1.6.3 Live Loads

- Building floors are usually subjected to uniform live loads or concentrated live loads. They have to be designed to safely support the *minimum uniformly distributed load* or the *minimum concentrated live load* values given in the ASCE 7-98 (see Table 1.4 below), whichever produces the maximum load effects in the structural members.

TABLE 4-1. Minimum Uniformly Distributed Live Loads, L_o , and Minimum Concentrated Live Loads

Occupancy or Use	Uniform psf (kN/m ²)	Concentration lb (kN)
Apartments (see residential)		
Access floor systems		
Office use	50 (2.4)	2,000 (8.9)
Computer use	100 (4.79)	2,000 (8.9)
Armories and drill rooms	150 (7.18)	
Assembly areas and theaters		
Fixed seats (fastened to floor)	60 (2.87)	
Lobbies	100 (4.79)	
Movable seats	100 (4.79)	
Platforms (assembly)	100 (4.79)	
Stage floors	150 (7.18)	
Balconies (exterior)	100 (4.79)	
On one- and two-family residences only, and not exceeding 100 ft ² (9.3 m ²)	60 (2.87)	
Bowling alleys, poolrooms and similar recreational areas	75 (3.59)	
Catwalks for maintenance access	40 (1.92)	300 (1.33)
Corridors		
First floor	100 (4.79)	
Other floors, same as occupancy served except as indicated		
Dance halls and ballrooms	100 (4.79)	
Decks (patio and roof)		
Same as area served, or for the type of occupancy accommodated		
Dining rooms and restaurants	100 (4.79)	
Dwellings (see residential)		
Elevator machine room grating [on area of 4 in. ² (2,580 mm ²)]		300 (1.33)
Finish light floor plate construction [on area of 1 in. ² (645 mm ²)]		200 (0.89)
Fire escapes	100 (4.79)	
On single-family dwellings only	40 (1.92)	
Fixed Ladders		See Section 4.4
Garages (passenger cars only)	50 (2.40)	
Trucks and buses		— ²
Grandstands (see stadium and arena bleachers)		
Gymnasiums, main floors and balconies	100 (4.79) ⁴	
Handrails, guardrails and grab bars		See Section 4.4
Hospitals		
Operating rooms, laboratories	60 (2.87)	1,000 (4.45)
Private rooms	40 (1.92)	1,000 (4.45)
Wards	40 (1.92)	1,000 (4.45)
Corridors above first floor	80 (3.83)	1,000 (4.45)
Hotels (see residential)		
Libraries		
Reading rooms	60 (2.87)	1,000 (4.45)
Stack rooms	150 (7.18) ¹	1,000 (4.45)
Corridors above first floor	80 (3.83)	1,000 (4.45)
Manufacturing		
Light	125 (6.00)	2,000 (8.90)
Heavy	250 (11.97)	3,000 (13.40)
Marquees and Canopies	75 (3.59)	
Office Buildings		
File and computer rooms shall be designed for heavier loads based on anticipated occupancy		
Lobbies and first floor corridors	100 (4.79)	2,000 (8.90)
Offices	50 (2.40)	2,000 (8.90)
Corridors above first floor	80 (3.83)	2,000 (8.90)

TABLE 4-1. Minimum Uniformly Distributed Live Loads, L_o , and Minimum Concentrated Live Loads (Continued)

Occupancy or Use	Uniform psf (kN/m ²)	Concentration lb (kN)
Penal Institutions		
Cell blocks	40 (1.92)	
Corridors	100 (4.79)	
Residential		
Dwellings (one- and two-family)		
Uninhabitable attics without storage	10 (0.48)	
Uninhabitable attics with storage	20 (0.96)	
Habitable attics and sleeping areas	30 (1.44)	
All other areas except stairs and balconies	40 (1.92)	
Hotels and multifamily houses		
Private rooms and corridors serving them	40 (1.92)	
Public rooms and corridors serving them	100 (4.79)	
Reviewing stands, grandstands and bleachers	100 (4.79) ⁴	
Roofs		See Sections 4.3 and 4.9
Schools		
Classrooms	40 (1.92)	1,000 (4.45)
Corridors above first floor	80 (3.83)	1,000 (4.45)
First floor corridors	100 (4.79)	1,000 (4.45)
Scuttles, skylight ribs, and accessible ceilings		200 (9.58)
Sidewalks, vehicular driveways, and yards, subject to trucking	250 (11.97) ⁵	8,000 (35.60) ⁶
Stadiums and Arenas		
Bleachers	100 (4.79) ⁴	
Fixed Seats (fastened to floor)	60 (2.87) ⁴	
Stairs and exitways	100 (4.79)	— ⁷
One- and two-family residences only	40 (1.92)	
Storage areas above ceilings	20 (0.96)	
Storage warehouses (shall be designed for heavier loads if required for anticipated storage)		
Light	125 (6.00)	
Heavy	250 (11.97)	
Stores		
Retail		
First floor	100 (4.79)	1,000 (4.45)
Upper floors	73 (3.59)	1,000 (4.45)
Wholesale, all floors	125 (6.00)	1,000 (4.45)
Vehicle barriers		See Section 4.4
Walkways and elevated platforms (other than exitways)	60 (2.87)	
Yards and terraces, pedestrians	100 (4.79)	

¹Floors in garages or portions of building used for the storage of motor vehicles shall be designed for the uniformly distributed live loads of Table 4-1 or the following concentrated load: (1) for passenger cars accommodating not more than nine passengers, 2,000 lb (8.90 kN) acting on an area of 20 in.² (12,900 mm²); (2) mechanical parking structures without slab or deck, passenger car only, 1,500 lb (6.70 kN) per wheel.

²Garages accommodating trucks and buses shall be designed in accordance with an approved method which contains provisions for truck and bus loadings.

³The weight of books and shelving shall be computed using an assumed density of 65 lb/ft³ (pounds per cubic foot, sometimes abbreviated pcf) (10.21 kN/m³) and converted to a uniformly distributed load; this load shall be used if it exceeds 150 lb/ft² (7.18 kN/m²).

⁴In addition to the vertical live loads, horizontal swaying forces parallel and normal to the length of seats shall be included in the design according to the requirements of ANSI/NFPA 102 [3].

⁵Other uniform loads in accordance with an approved method which contains provisions for truck loadings shall also be considered where appropriate.

⁶The concentrated wheel load shall be applied on an area of 20 in.² (12,900 mm²).

⁷Minimum concentrated load on stair treads [on area of 4 in.² (2,580 mm²)] is 300 lb (1.33 kN).

- The minimum uniformly distributed live loads (L_o) given in Table 1.4 above can be reduced for buildings with *very large floor areas*, because it is unlikely that the prescribed live load will occur simultaneously throughout the entire structure.
- Equation (1.1) can be used to calculate the reduce uniformly distributed live load (L)

$$L = L_o \left(0.25 + \frac{4.57}{\sqrt{K_{LL} A_T}} \right) \quad (1.1)$$

where, A_T is the tributary area in ft^2 and K_{LL} is the live load element factor as follows:

K_{LL} is equal to 4.0 for interior columns and exterior columns without cantilever slabs. K_{LL} is equal to 3.0 for edge columns with cantilever slabs.

K_{LL} is equal to 2.0 for corner columns with cantilever slabs, edge beams without cantilever slabs, and interior beams.

K_{LL} is equal to 1.0 for all other members not identified above.

- Some limitations to the live load reduction are as follows:

L cannot be less than $0.5L_o$ for members supporting one floor and L cannot be less than $0.4L_o$ for members supporting two or more floors.

Live loads that exceed 100 lb/ft^2 shall not be reduced except the live loads for members supporting two or more floors may be reduced by 20%.

Live loads exceeding 100 lb/ft^2 shall not be reduced for passenger car garages, public assembly occupancies, or roofs

1.6.4 Roof Live Loads

Ordinary flat, pitched, and curved roofs shall be designed for the live loads specified in Equation 1.2 (from ASCE 7-98).

$$L_r = 20 R_1 R_2 \quad \text{where, } 12 \leq L_r \leq 20 \quad (1.2)$$

where,

L_r is the roof live load per square foot of horizontal projection in psf.

$$= 1 \quad \text{for } A_T \leq 200 \text{ ft}^2$$

$$\mathbf{R_1} = 1.2 - 0.001 A_T \quad \text{for } 200 < A_T < 600 \text{ ft}^2$$

$$= 0.6 \quad \text{for } 600 \text{ft}^2 \leq A_T$$

$$= 1 \quad \text{for } F \leq 4$$

$$\mathbf{R_2} = 1.2 - 0.05 F \quad \text{for } 4 < F < 12$$

$$= 0.6 \quad \text{for } 12 \leq F$$

where, F = no. of inches of rise per foot for pitched roof.

1.6.5 Wind Loads

- Design wind loads for buildings can be based on: (a) simplified procedure; (b) analytical procedure; and (c) wind tunnel or small-scale procedure.
- Refer to ASCE 7-98 for the simplified procedure. This simplified procedure is applicable only to buildings with mean roof height less than 30 ft.
- The wind tunnel procedure consists of developing a small-scale model of the building and testing it in a wind tunnel to determine the expected wind pressures etc. It is expensive and may be utilized for difficult or special situations.
- The analytical procedure is used in most design offices. It is fairly systematic but somewhat complicated to account for the various situations that can occur:
- Wind velocity will cause pressure on any surface in its path. The wind velocity and hence the velocity pressure depend on the height from the ground level. Equation 1.3 is recommended by ASCE 7-98 for calculating the velocity pressure (q_z) in lb/ft²

$$q_z = 0.00256 K_z K_{zt} K_d V^2 I \quad (\text{lb/ft}^2) \quad (1.3)$$

where, V is the wind velocity (see Figure 6-1 in ASCE 7-98)

K_d is a directionality factor (=0.85 for CE 405)

K_{zt} is a topographic factor (= 1.0 for CE 405)

I is the importance factor (=1.0 for CE 405)

K_z varies with height z above the ground level (see Table 6-5 in ASCE 7-98)

- A significant portion of the U.S. including Lansing has $V = 90$ mph. At these location

$$q_z = 17.625 K_z \quad (\text{lb/ft}^2) \quad (1.4)$$

- The velocity pressure q_z is used to calculate the design wind pressure (p) for the building structure as follows:

$$p = q GC_p - q_i (GC_{pi}) \quad (\text{lb/ft}^2) \quad (1.5)$$

where, G = gust effect factor (=0.85 for CE 405)

C_p = external pressure coefficient from Figure 6-3 in ASCE 7-98

C_{pi} = internal pressure coefficient from Table 6-7 in ASCE 7-98

q depends on the orientation of the building wall or roof with respect to direction of the wind as follows:

$q = q_z$ for the windward wall – varies with height z

$q = q_h$ for leeward wall.

q_h is q_z evaluated at $z = h$ (mean height of building). q_h is constant.

$q_i = q_h$ for windward, leeward, side walls and roofs.

- Note that a positive sign indicates pressure acting towards a surface. Negative sign indicate pressure away from the surface
- Equation 1.5 indicates that the design wind pressure p consists of two components: (1) the external pressure on the building ($q GC_p$); and (2) the internal pressure in the building ($q_h GC_{pi}$)

1.6.6 Load and Resistance Factor Design

The load and resistance factor design approach is recommended by AISC for designing steel structures. It can be understood as follows:

Step I. Determine the ultimate loads acting on the structure

- The values of D, L, W, etc. given by ASCE 7-98 are nominal loads (not maximum or ultimate)

- During its design life, a structure can be subjected to some maximum or ultimate loads caused by combinations of D, L, or W loading.
- The ultimate load on the structure can be calculated using factored load combinations, which are given by ASCE and AISC (see pages 2-10 and 2-11 of AISC manual). The most relevant of these load combinations are given below:

$$1.4 D \quad (4.2 - 1)$$

$$1.2 D + 1.6 L + 0.5 (L_r \text{ or } S) \quad (4.2 - 2)$$

$$1.2 D + 1.6 (L_r \text{ or } S) + (0.5 L \text{ or } 0.8 W) \quad (4.2 - 3)$$

$$1.2 D + 1.6 W + 0.5 L + 0.5 (L_r \text{ or } S) \quad (4.2 - 4)$$

$$0.9 D + 1.6 W \quad (4.2 - 5)$$

Step II. Conduct linear elastic structural analysis

- Determine the design forces (P_u , V_u , and M_u) for each structural member

Step III. Design the members

- The failure (design) strength of the designed member must be greater than the corresponding design forces calculated in Step II. See Equation (4.3) below:

$$\phi R_n > \sum \gamma_i Q_i \quad (4.3)$$

- Where, R_n is the calculated failure strength of the member
- ϕ is the resistance factor used to account for the reliability of the material behavior and equations for R_n
- Q_i is the nominal load
- γ_i is the load factor used to account for the variability in loading and to estimate the ultimate loading condition.

Example 1.1

Consider the building structure with the structural floor plan and elevation shown below.

Estimate the wind loads acting on the structure when the wind blows in the east-west direction.

The structure is located in Lansing.

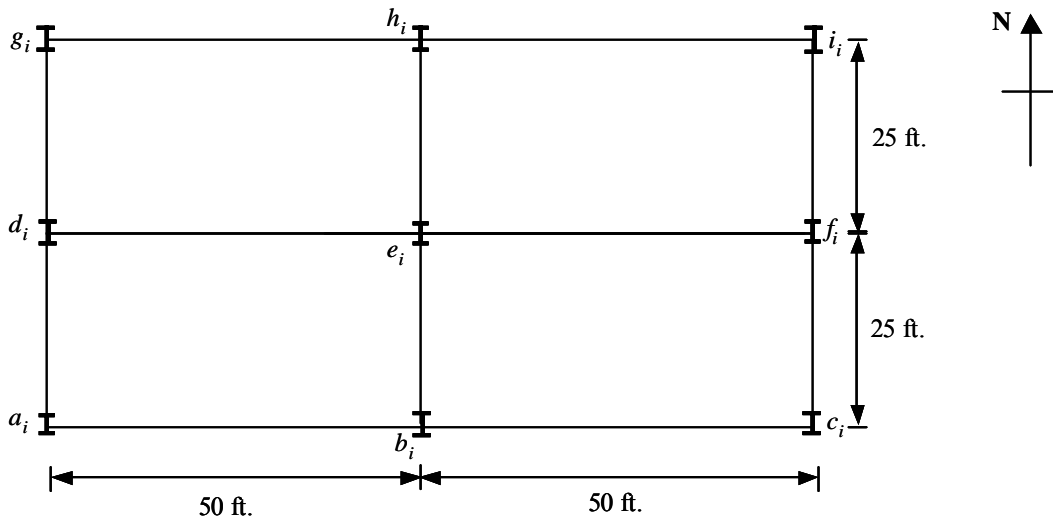

Figure 8. Structural floor plan

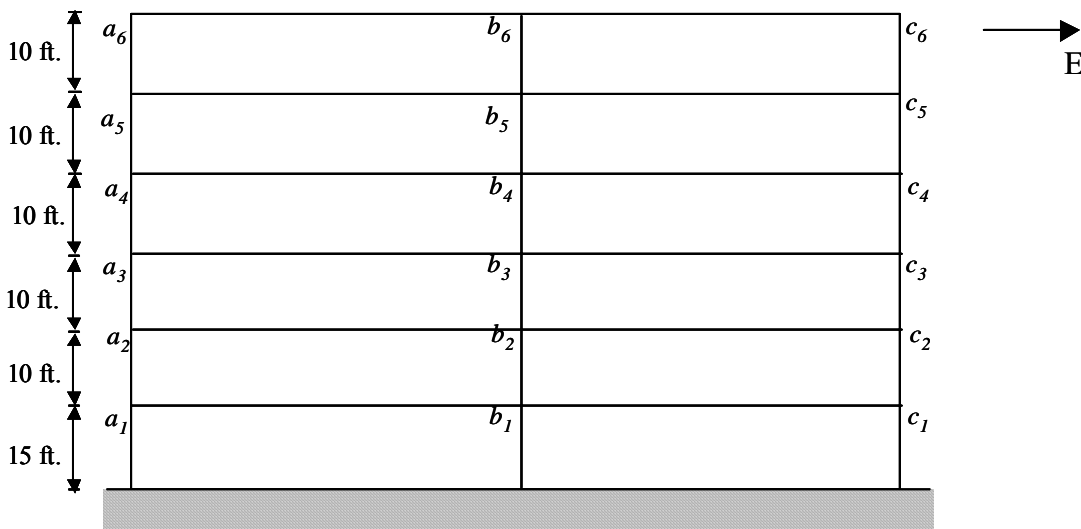

Figure 9. Structural elevation in east-west direction

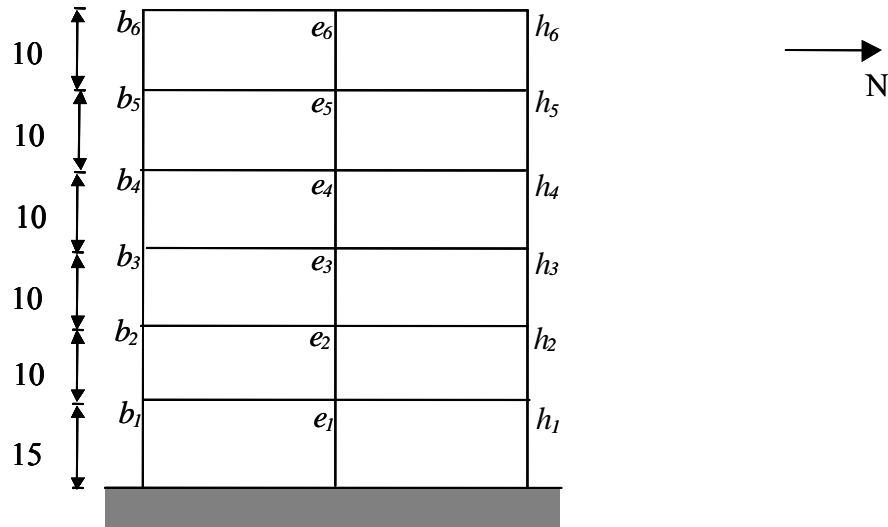

Figure 10. Structural elevation in north-south direction

- Velocity pressure (q_z)
 - K_d = directionality factor = 0.85
 - K_{zt} = topographic factor = 1.0
 - I = importance factor = 1.0
 - K_h values for Exposure B, Case 2

K_h	z
0.57	0 - 15
0.62	15 - 20
0.66	20 - 25
0.70	25 - 30
0.76	30 - 40
0.81	40 - 50
0.85	50 - 60
0.89	60 - 70

- $q_z = 0.00256 K_z K_{zt} K_d V^2 I$
 - In Lansing $V = 90$ mph

- $q_z = 17.625 K_z$ psf
- Wind pressure (p)
 - Gust factor = $G = 0.85$
 - For wind in east west direction; $L/B = \text{Length} / \text{width} = 2.0$
 - External pressure coefficient = $C_p = +0.8$ for windward walls
 $C_p = -0.3$ for leeward walls
 $C_p = -0.7$ for side walls
 - External pressure = $q G C_p$
 - External pressure on windward wall = $q_z G C_p = 17.625 K_z \times 0.85 \times 0.8$
 $= 11.99 K_z$ psf toward surface
 - External pressure on leeward wall = $q_h G C_p = 17.625 K_{65} \times 0.85 \times (-0.3)$
 $= 4.00$ psf away from surface
 - External pressure on side wall = $q_h G C_p = 17.625 K_{65} \times 0.85 \times (-0.7)$
 $= 9.33$ psf away from surface
 - The external pressures on the structure are shown in Figures 11 and 12 below.

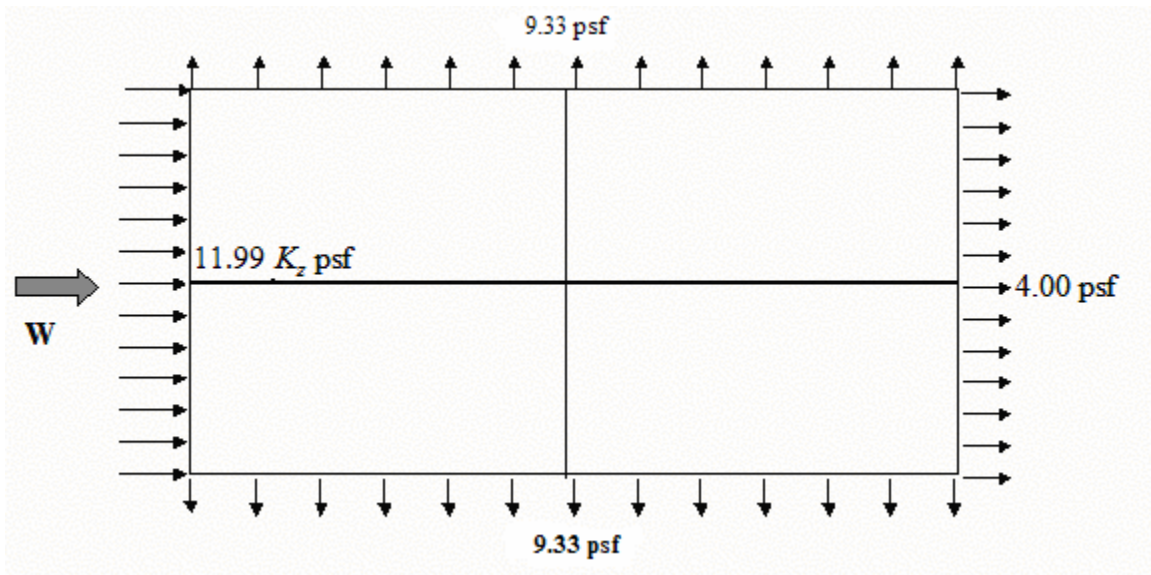

Figure 11. External pressures on structural plan

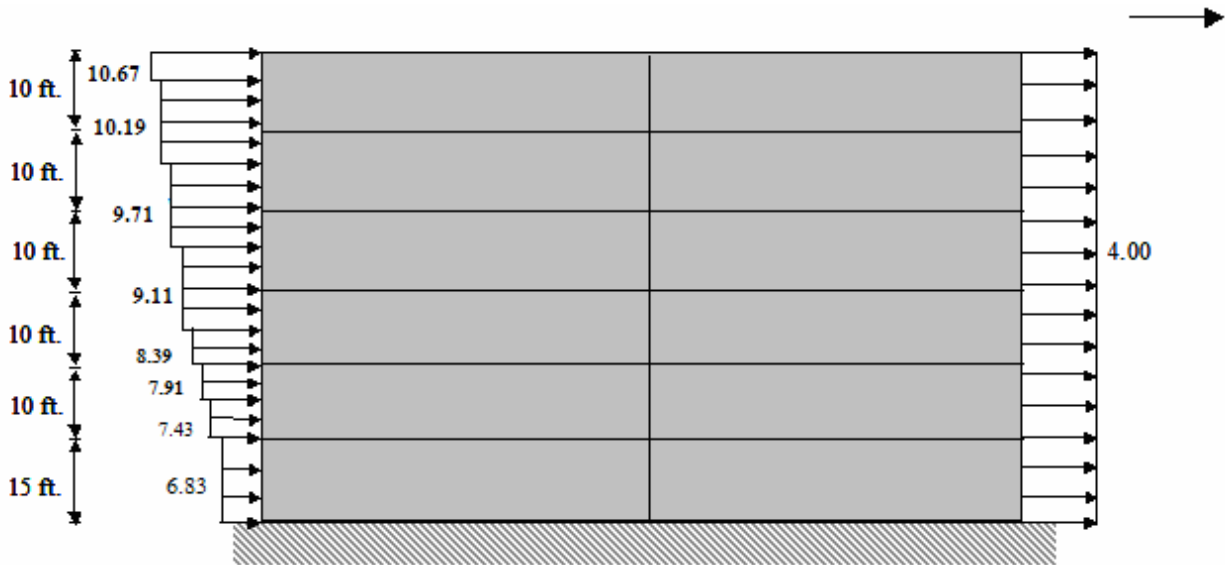

Figure 12. External pressure on structural elevation (east west)

- Internal pressure

- $p = q GC_p - q_i GC_{pi}$

- $q_i = q_h = 17.625 K_{65} = 17.625 \times 0.89 = 15.69 \text{ psf}$

- Enclosed building; $GC_{pi} = +0.18$ (acting toward surface)
 $GC_{pi} = -0.18$ (acting away from surface)

- $q_i GC_{pi} = 2.82 \text{ psf}$ acting toward or away from surface

- See Figure 13 (a) and (b) below

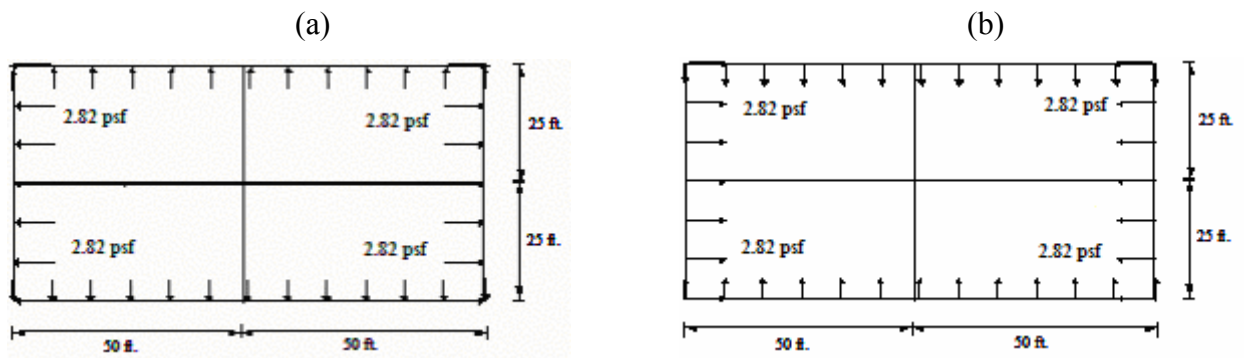

Figure 13. Internal pressure seen in structural plan

- Take the external pressure from Figure 11 and 12 and add to internal pressure from Figures 13 (a) and (b) to obtain the final pressure diagrams. Adding the internal pressure will not change the lateral forces in the structure.

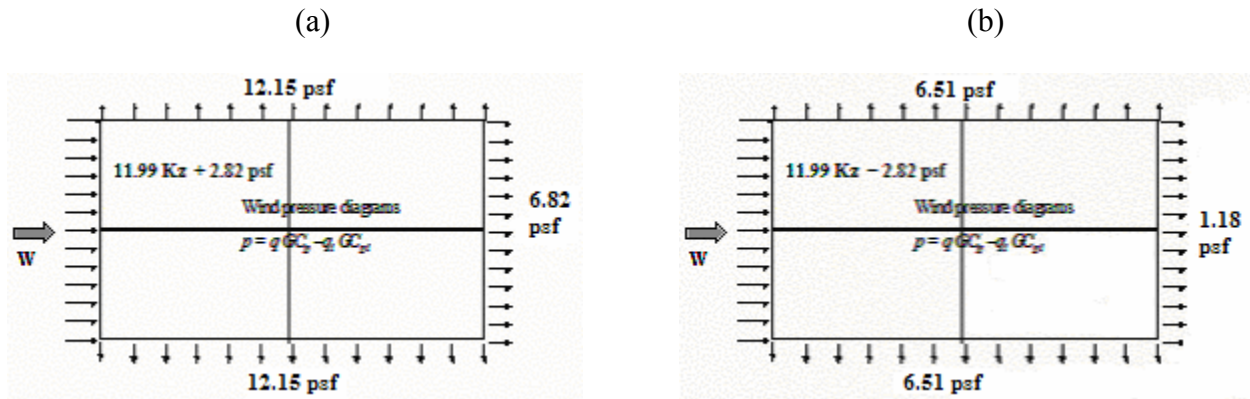

Figure 14. Resultant wind pressure diagrams including external and internal pressures

- Note: According to ASCE 7-98, the minimum wind design loading is equal to 10 lb/ft^2 multiplied by the area of the building projected on a vertical plane normal to assumed wind direction.
- The determined design wind loading is greater than the *minimum* value. Therefore, continue with estimated design wind loading.

Example 1.2 Determine the magnitude and distribution of live loading on the north-south frame $b_i - e_i - h_i$

- Step I: Determine relevant tributary and influence areas. Estimate live load reduction factors.

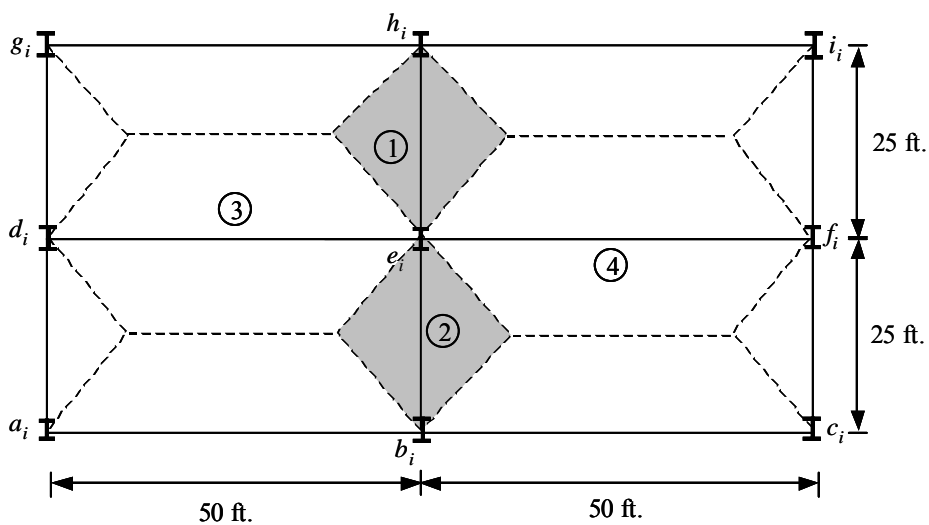
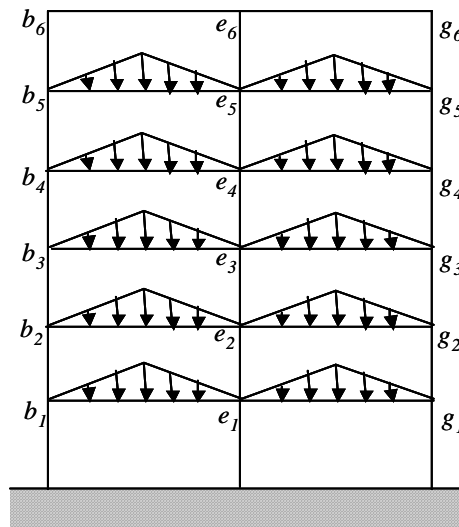

Table 1.1 Member tributary areas and minimum design live loading.

Member	Tributary area	K_{LL}	$L_o/L=0.25 + 4.57/(K_{LL}A_T)^{0.5}$	L_o/L min.
$b_i - e_i$	$A_{T2} = \frac{1}{2} \times 25.0 \times 12.5 \times 2$ $= 312.5 \text{ ft}^2$	2.0	0.4328	0.5
$e_i - h_i$	$A_{T1} = \frac{1}{2} \times 25.0 \times 12.5 \times 2$ $= 312.5 \text{ ft}^2$	2.0	0.4328	0.5
$d_i - e_i$	$A_{T3} = \frac{1}{2} \times 12.5 \times 25.0 \times 2 +$ $25.0 \times 25.0 = 937.5 \text{ ft}^2$	2.0	0.36	0.5
$e_i - f_i$	$A_{T4} = \frac{1}{2} \times 12.5 \times 25.0 \times 2 +$ $25.0 \times 25.0 = 937.5 \text{ ft}^2$	2.0	0.36	0.5
b_i	$12.5 \times 50.0 = 625.0 \text{ ft}^2$	4.0	0.34	0.4
e_i	$25.0 \times 50.0 = 1250.0 \text{ ft}^2$	4.0	0.3146	0.4
h_i	$12.5 \times 50.0 = 625 \text{ ft}^2$	4.0	0.34	0.4

- Step II. Estimate uniformly distributed loads



- Step III: Estimate live loading on columns from other frames than the one being investigated.

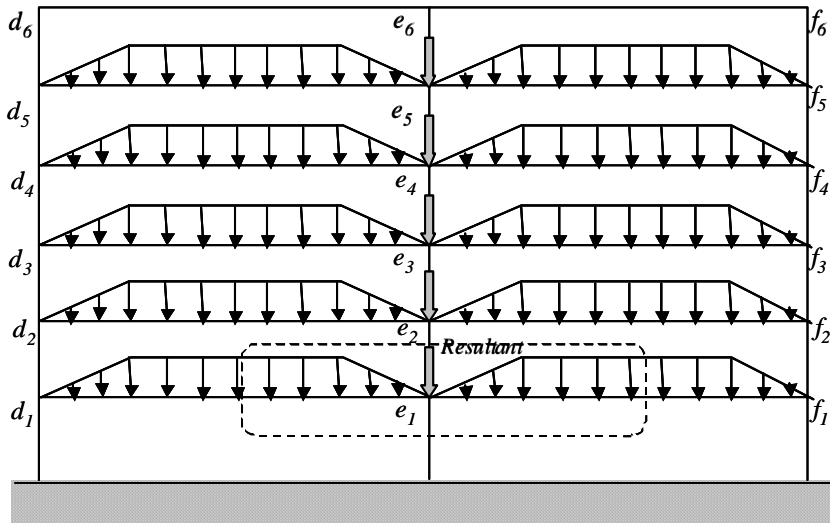

- Note: The minimum reduced live load for the column e_i from Table 1 = $0.40 L_o$. However, the live loading on column e_i is being estimated using the reduced live loading on the beams. For consistency, make sure that the reduced beam live loading is not less than the reduced column live loading.
- Note: The wind pressures act on the sides of the building. The lateral forces acting on the frame are calculated using these wind pressures and the tributary area concept.

ASCE 7 – 98 pg. 39

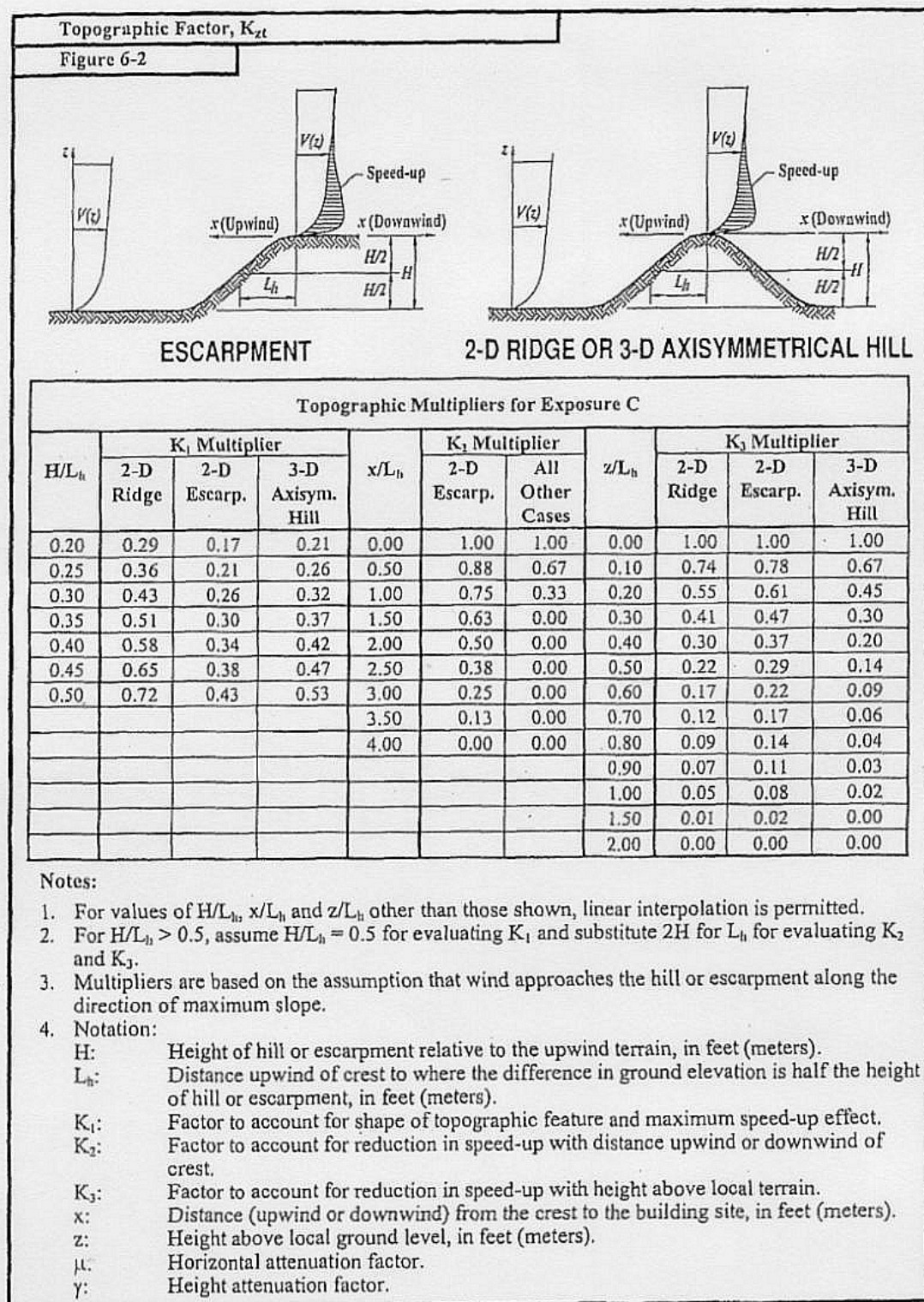
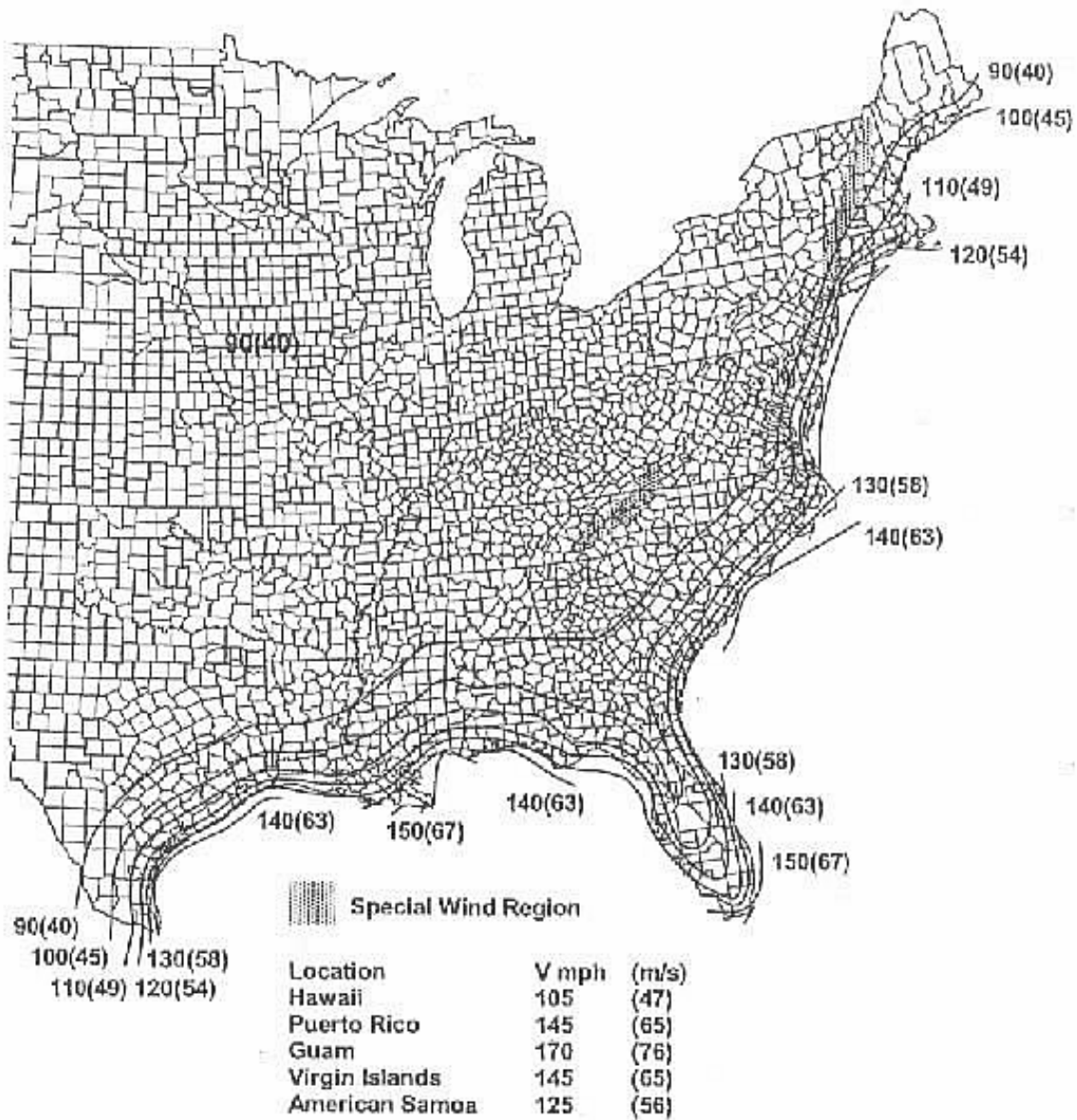

Figure showing the Wind Speed of Eastern US. (ASCE 7 – 98 pg. 35)



Notes:

1. Values are nominal design 3-second gust wind speeds in miles per hour (m/s) at 33 ft (10 m) above ground for Exposure C category.
2. Linear Interpolation between wind contours is permitted.
3. Islands and coastal areas outside the last contour shall use the last wind speed contour of the coastal area.
4. Mountainous terrain, gorges, ocean promontories, and special wind regions shall be examined for unusual wind conditions.

FIGURE 6-1. (Continued)

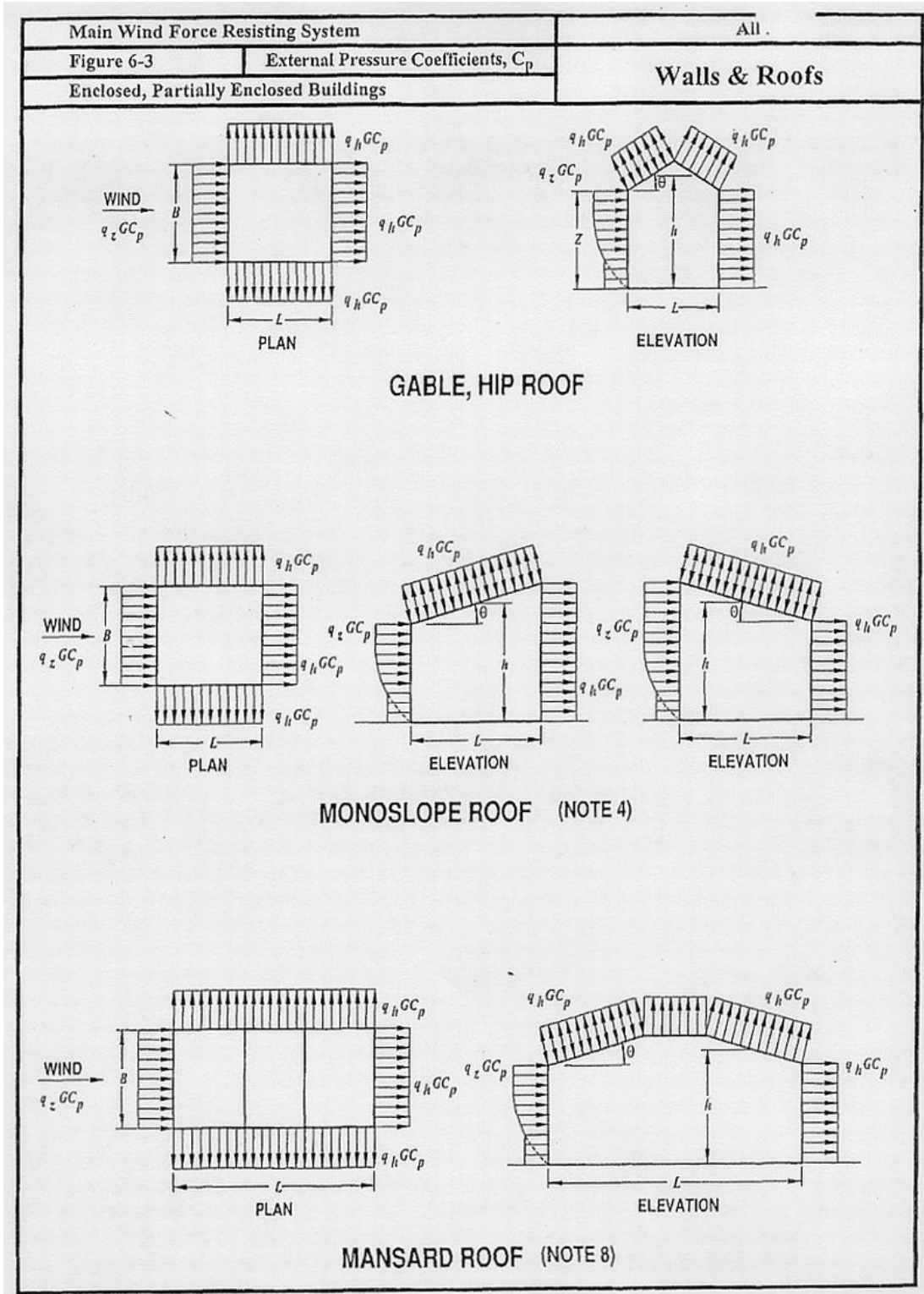

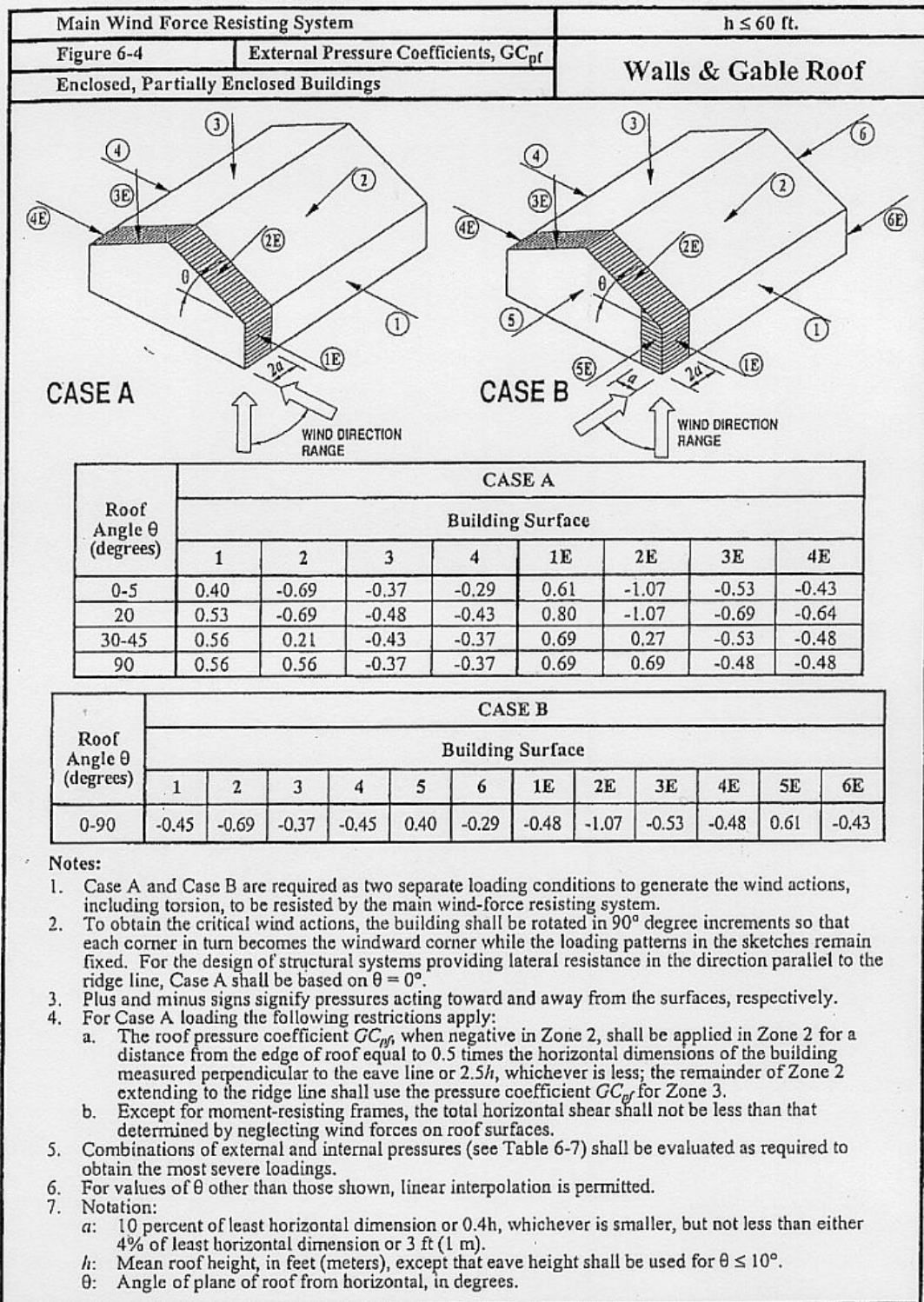

Main Wind Force Resisting System		All h											
Figure 6-3 (con't)	External Pressure Coefficients, C_p	Walls & Roofs											
Enclosed, Partially Enclosed Buildings													
Wall Pressure Coefficients, C_p													
Surface	L/B	C_p	Use With										
Windward Wall	All values	0.8	q_z										
Leeward Wall	0-1	-0.5	q_h										
	2	-0.3											
	≥ 4	-0.2											
Side Wall	All values	-0.7	q_h										
Roof Pressure Coefficients, C_p , for use with q_h													
Wind Direction	Windward										Leeward		
	Angle, θ (degrees)												
	h/L	10	15	20	25	30	35	45	$\geq 60^\#$	10	15	≥ 20	
Normal to ridge for $\theta \geq 10^\circ$	≤ 0.25	-0.7	-0.5	-0.3	-0.2	-0.2	0.0*	0.4	0.4	0.01 θ	-0.3	-0.5	-0.6
	0.5	-0.9	-0.7	0.4	-0.3	-0.2	-0.2	0.0*	0.4	0.01 θ	-0.5	-0.5	-0.6
	≥ 1.0	-1.3**	-1.0	-0.7	-0.5	-0.3	-0.2	0.0*	0.3	0.01 θ	-0.7	-0.6	-0.6
Normal to ridge for $\theta < 10^\circ$ and Parallel to ridge for all θ	≤ 0.5	Horiz distance from windward edge		C_p		*Value is provided for interpolation purposes. **Value can be reduced linearly with area over which it is applicable as follows							
		0 to $h/2$		-0.9									
		$h/2$ to h		-0.9									
		h to $2h$		-0.5									
≥ 1.0	0 to $h/2$	C_p		-1.3**		Area (sq ft)		Reduction Factor					
						≤ 100 (9.29 sq m)		1.0					
						200 (23.23 sq m)		0.9					
						≥ 1000 (92.9 sq m)		0.8					

Notes:

- Plus and minus signs signify pressures acting toward and away from the surfaces, respectively
- Linear interpolation is permitted for values of L/B , h/L and θ other than shown. Interpolation shall only be carried out between values of the same sign. Where no value of the same sign is given, assume 0.0 for interpolation purposes.
- Where two values of C_p are listed, this indicates that the windward roof slope is subjected to either positive or negative pressures and the roof structure shall be designed for both conditions. Interpolation for intermediate ratios of h/L in this case shall only be carried out between C_p values of like sign.
- For monoslope roofs, entire roof surface is either a windward or leeward surface.
- For flexible buildings use appropriate G_f as determined by rational analysis.
- Refer to Table 6-8 for arched roofs.
- Notation:
 - B : Horizontal dimension of building, in feet (meter), measured normal to wind direction.
 - L : Horizontal dimension of building, in feet (meter), measured parallel to wind direction.
 - h : Mean roof height in feet (meters), except that eave height shall be used for $\theta \leq 10$ degrees.
 - z : Height above ground, in feet (meters).
 - G : Gust effect factor.
 - q_z, q_h : Velocity pressure, in pounds per square foot (N/m^2), evaluated at respective height.
 - θ : Angle of plane of roof from horizontal, in degrees.
- For mansard roofs, the top horizontal surface and leeward inclined surface shall be treated as leeward surfaces from the table.

#For roof slopes greater than 80° , use $C_p = 0.8$

Importance factor ASCE 7 – 98 pg. 55

Category	Non-Hurricane Prone Regions and Hurricane Prone Regions with V = 85-100 mph and Alaska	Hurricane Prone Regions with V > 100 mph
I	0.87	0.77
II	1.00	1.00
III	1.15	1.15
IV	1.15	1.15

Note:

- The building and structure classification categories are listed in Table 1-1.

wind directionality factor asce 7 – 98 pg.

Structure Type	Directionality Factor K_d *
Buildings Main Wind Force Resisting System Components and Cladding	0.85 0.85
Arched Roofs	0.85
Chimneys, Tanks, and Similar Structures Square Hexagonal Round	0.90 0.95 0.95
Solid Signs	0.85
Open Signs and Lattice Framework	0.85
Trussed Towers Triangular, square, rectangular All other cross sections	0.85 0.95

*Directionality Factor K_d has been calibrated with combinations of loads specified in Section 2. This factor shall only be applied when used in conjunction with load combinations specified in 2.3 and 2.4.

velocity pressure exposure coefficient

Velocity Pressure Exposure Coefficients, K_z and K_{zt}							
Table 6-5							
Height above ground level, z		Exposure (Note 1)					
		A		B		C	D
ft	(m)	Case 1	Case 2	Case 1	Case 2	Cases 1 & 2	Cases 1 & 2
0-15	(0-4.6)	0.68	0.32	0.70	0.57	0.85	1.03
20	(6.1)	0.68	0.36	0.70	0.62	0.90	1.08
25	(7.6)	0.68	0.39	0.70	0.66	0.94	1.12
30	(9.1)	0.68	0.42	0.70	0.70	0.98	1.16
40	(12.2)	0.68	0.47	0.76	0.76	1.04	1.22
50	(15.2)	0.68	0.52	0.81	0.81	1.09	1.27
60	(18)	0.68	0.55	0.85	0.85	1.13	1.31
70	(21.3)	0.68	0.59	0.89	0.89	1.17	1.34
80	(24.4)	0.68	0.62	0.93	0.93	1.21	1.38
90	(27.4)	0.68	0.65	0.96	0.96	1.24	1.40
100	(30.5)	0.68	0.68	0.99	0.99	1.26	1.43
120	(36.6)	0.73	0.73	1.04	1.04	1.31	1.48
140	(42.7)	0.78	0.78	1.09	1.09	1.36	1.52
160	(48.8)	0.82	0.82	1.13	1.13	1.39	1.55
180	(54.9)	0.86	0.86	1.17	1.17	1.43	1.58
200	(61.0)	0.90	0.90	1.20	1.20	1.46	1.61
250	(76.2)	0.98	0.98	1.28	1.28	1.53	1.68
300	(91.4)	1.05	1.05	1.35	1.35	1.59	1.73
350	(106.7)	1.12	1.12	1.41	1.41	1.64	1.78
400	(121.9)	1.18	1.18	1.47	1.47	1.69	1.82
450	(137.2)	1.24	1.24	1.52	1.52	1.73	1.86
500	(152.4)	1.29	1.29	1.56	1.56	1.77	1.89

Notes:

- Case 1: a. All components and cladding.
b. Main wind force resisting system in low-rise buildings designed using Figure 6-4.
- Case 2: a. All main wind force resisting systems in buildings except those in low-rise buildings designed using Figure 6-4.
b. All main wind force resisting systems in other structures.

2. The velocity pressure exposure coefficient K_z may be determined from the following formula:

For $15 \text{ ft.} \leq z \leq z_g$	For $z < 15 \text{ ft.}$
$K_z = 2.01 (z/z_g)^{2/\alpha}$	$K_z = 2.01 (15/z_g)^{2/\alpha}$

Note: z shall not be taken less than 100 feet for Case 1 in exposure A or less than 30 feet for Case 1 in exposure B.

- α and z_g are tabulated in Table 6-4.
- Linear interpolation for intermediate values of height z is acceptable.
- Exposure categories are defined in 6.5.6.

internal pressure coefficient for buildings

Enclosure Classification	GC_{pi}
Open Buildings	0.00
Partially Enclosed Buildings	+0.55 -0.55
Enclosed Buildings	+0.18 -0.18

Notes:

1. Plus and minus signs signify pressures acting toward and away from the internal surfaces.
2. Values of GC_{pi} shall be used with q_z or q_h as specified in 6.5.12.
3. Two cases shall be considered to determine the critical load requirements for the appropriate condition:
 - (i) a positive value of GC_{pi} applied to all internal surfaces
 - (ii) a negative value of GC_{pi} applied to all internal surfaces